

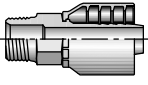









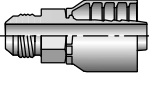
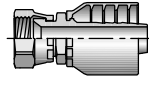
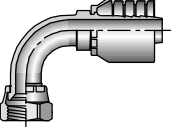

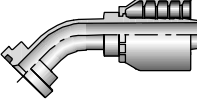
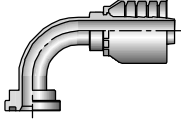
 <b>NPTF Pipe</b>	10170 B-62  Male - Rigid	 <b>JIC 37°</b>	10370 B-62  Male - Rigid	10670 B-62  Female - Swivel	13970 B-62  Female - Swivel 90° Elbow - Short
 <b>Code 61 Flange</b>	11770 B-63  45° Elbow	11970 B-63  90° Elbow	 <b>Code 62 Flange</b>	16A70 B-63  Flange Head	16N70 B-64  90° Elbow
 <b>Seal-Lok® (O-Ring Face Seal)</b>	1JC70 B-64  Female - Swivel Short	1JS70 B-64  Female - Swivel Long	1J770 B-64  Femal - Swivel 45° Elbow	1J970 B-65  Female - Swivel 90° Elbow - Short	1J570 B-65  Female - Swivel 90° Elbow - Medium
1J170 B-65  Female - Swivel 90° Elbow - Long	 <b>BSP 60° Cone</b>	1GU70 B-66  Female - Swivel	 <b>French Gaz</b>	1FG70 B-66  Male - Rigid	 <b>Metric</b>
10C70 B-67  Female Metric S - Swivel - 45° Elbow	11C70 B-67  Female Metric S - Swivel - 90° Elbow	19270 B-67  Female BSP - Swivel - 60° Cone	1B170 B-67  Female BSP - Swivel - 45° Elbow	1B270 B-68  Female BSP - Swivel - 90° Elbow	1C970 B-68  Female - Swivel
1CA70 B-68  Female Metric L - Swivel - 24° Cone	1CE70 B-68  Female Metric L - Swivel - 45° Elbow	1CF70 B-69  Female Metric L - Swivel - 90° Elbow	1D270 B-69  Male Metric S - Rigid	1D970 B-69  Male - BSP - Rigid	

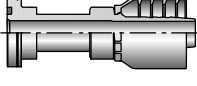
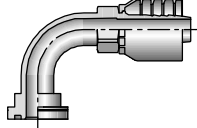
A

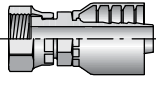
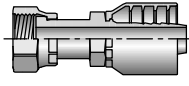
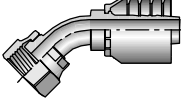
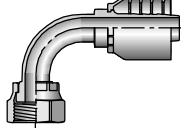
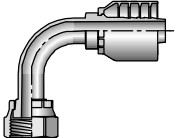
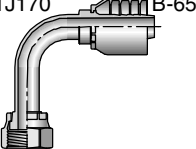
B

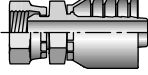
C

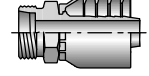
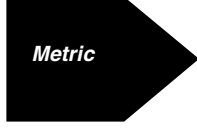
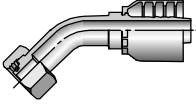
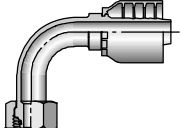
D

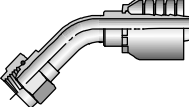
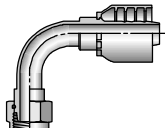
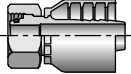
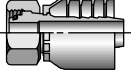
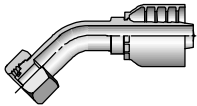
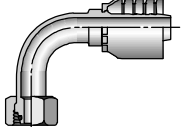
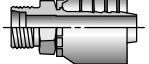
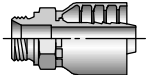
E

A

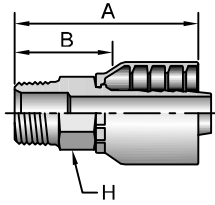

### 10170 Male NPTF Pipe - Rigid

# Part Number	Thread		Hose I.D.		A		H		B	
	inch		inch		inch	mm	inch		inch	mm
10170-6-6	3/8x18		3/8		2.37	60	3/4		1.47	37
10170-8-8	1/2x14		1/2		2.84	72	7/8		1.40	36

B

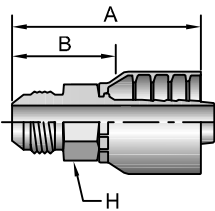

### 10370 Male JIC 37° - Rigid

# Part Number	Thread		Hose I.D.		A		H		B	
	inch		inch		inch	mm	inch		inch	mm
10370-8-8	1/2	3/4x16	1/2		2.68	68	7/8		1.47	37
10370-10-8	5/8	7/8x14	1/2		2.62	66	15/16		1.41	36

C

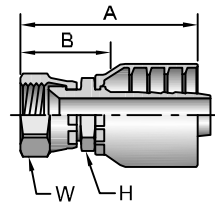

### 10670 Female JIC 37° - Swivel

# Part Number	Thread		Hose I.D.		A		H	W	B	
	inch		inch		inch	mm	inch	inch	inch	mm
10670-6-6	3/8	9/16x18	3/8		2.29	58	11/16	11/16	1.39	35
10670-8-8	1/2	3/4x16	1/2		2.62	67	13/16	7/8	1.41	36
10670-10-8	5/8	7/8x14	1/2		2.85	72	7/8	1	1.64	42
10670-10-10	5/8	7/8x14	5/8		2.84	72	15/16	1	1.59	40

D

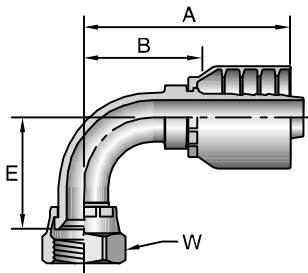

### 13970 Female JIC 37° - Swivel - 90° Elbow - Short Drop

# Part Number	Thread		Hose I.D.		A		E		W		B	
	inch		inch		inch	mm	inch	mm	inch		inch	mm
13970-8-8	1/2	3/4x16	1/2		2.62	67	1.14	29	7/8		1.41	36

E

## 11770

SAE Code 61 Flange Head - 45° Elbow  
ISO 12151-3 - 45S - L

# Part Number	Flange inch	Hose I.D. inch	A		E		F inch	B	
			inch	mm	inch	mm		inch	mm
11770-8-8	1/2	1/2	3.28	83	0.77	20	1-3/16	2.07	53
11770-12-10	3/4	5/8	3.37	86	0.76	19	1-1/2	2.12	54

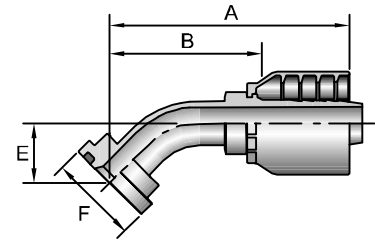

## 11970

SAE Code 61 Flange Head - 90° Elbow  
ISO 12151-3 - E90S - L

# Part Number	Flange inch	Hose I.D. inch	A		E		F inch	B	
			inch	mm	inch	mm		inch	mm
11970-8-8	1/2	1/2	2.93	74	1.60	41	1-3/16	1.72	44
11970-12-10	3/4	5/8	3.54	90	2.02	51	1-1/2	2.29	58

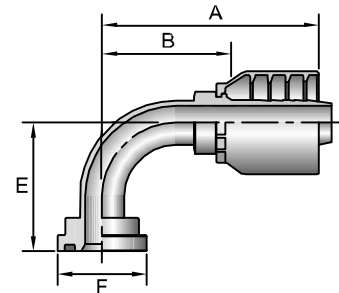

## 16A70

SAE Code 62 Flange Head  
ISO 12151-3 - S - S

# Part Number	Flange inch	Hose I.D. inch	A		F inch	B	
			inch	mm		inch	mm
16A70-8-8	1/2	1/2	3.50	88,9	1-1/4	2.29	56,9

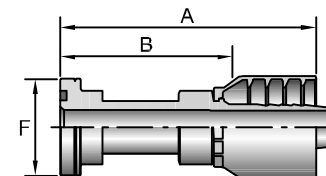

See Accessories Section for O-Rings and Flange Kits.

A

B

C

D

E

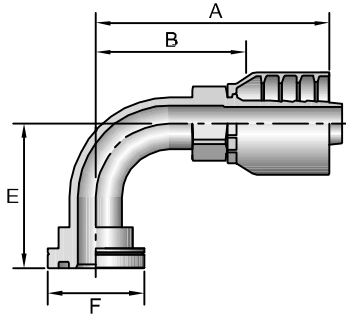

A



## 16N70

### SAE Code 62 Flange Head - 90° Elbow

ISO 12151-3 - E90S - S ( 1 Piece: ISO 12151-3 - E90M - S)

#			A		E			B	
Part Number	Flange inch	Hose I.D. inch	inch	mm	inch	mm	inch	inch	mm
16N70-8-8	1/2	1/2	2.60	66	1.61	41	1-1/4	1.34	34



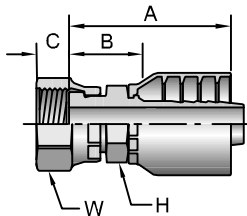

B



## 1JC70

### Female Seal-Lok® - Swivel - Short

ISO 12151- 1 - SWSA

#			A		C				B	
Part Number	Thread inch	Hose I.D. inch	inch	mm	inch	mm	inch	inch	inch	mm
1JC70-6-6	3/8 11/16x16	3/8	1.94	49	0.34	9	11/16	13/16	1.04	26
1JC70-8-6	1/2 13/16x16	3/8	2.00	51	0.43	11	13/16	15/16	1.10	28
1JC70-8-8	1/2 13/16x16	1/2	2.22	56	0.43	11	13/16	15/16	1.01	26
1JC70-10-10	5/8 1x14	5/8	2.40	61	0.53	13	15/16	1-1/8	1.15	29



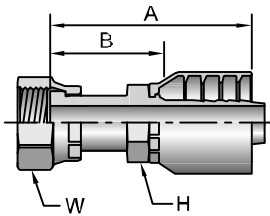

C



## 1JS70

### Female Seal-Lok® - Swivel - Long

ISO 12151-1 - SWSB

#			A				B	
Part Number	Thread inch	Hose I.D. inch	inch	mm	inch	inch	inch	mm
1JS70-6-6	3/8 11/16x16	3/8	2.28	58	11/16	13/16	1.38	35
1JS70-8-8	1/2 13/16x16	1/2	2.65	67	13/16	15/16	1.44	37
1JS70-12-8	3/4 1-3/16x12	1/2	2.90	74	1-1/8	1-3/8	1.69	43
1JS70-12-10	3/4 1-3/16x12	5/8	3.10	79	1-1/8	1-3/8	1.85	47



D

## 1J770

### Female Seal-Lok® - Swivel - 45° Elbow

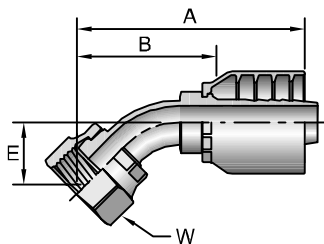
ISO 12151-1 - SWE45



#			A		E			B	
Part Number	Thread inch	Hose I.D. inch	inch	mm	inch	mm	inch	inch	mm
1J770-10-10	5/8 1x14	5/8	3.08	78	0.63	16	1-1/8	1.83	46

E

See Accessories Section for O-Rings and Flange Kits.

## 1J970

Female Seal-Lok® - Swivel - 90° Elbow - Short Drop  
ISO 12151-1 - SWES90

# Part Number	Thread		Hose I.D. inch	A		E		W inch	B	
	inch	mm		inch	mm	inch	mm		inch	mm
1J970-8-8	1/2	13/16x16	1/2	2.59	66	1.14	29	15/16	1.38	35
1J970-12-8	3/4	1-3/16x12	1/2	3.21	82	1.88	48	1-3/8	2.00	51

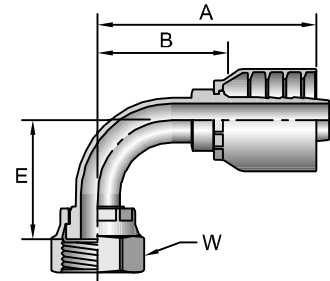

## 1J570

Female Seal-Lok® - Swivel - 90° Elbow - Medium Drop  
ISO 12151-1 - SWEM90

# Part Number	Thread		Hose I.D. inch	A		E		W inch	B	
	inch	mm		inch	mm	inch	mm		inch	mm
1J570-10-10	5/8	1x14	5/8	2.88	73	1.85	47	1-1/8	1.63	41

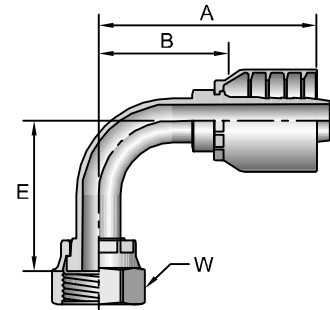

## 1J170

Female Seal-Lok® - Swivel - 90° Elbow - Long Drop  
ISO 12151-1 - SWEL90

# Part Number	Thread		Hose I.D. inch	A		E		W inch	B	
	inch	mm		inch	mm	inch	mm		inch	mm
1J170-8-8	1/2	13/16x16	1/2	2.59	66	2.52	65	15/16	1.38	35
1J170-10-10	5/8	1x14	5/8	2.88	73	2.76	70	1-1/8	1.63	41

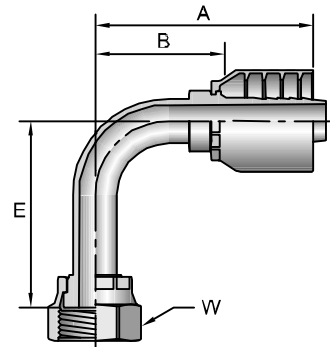

See Accessories Section for O-Rings and Flange Kits.

## 1GU70

Female BSP Parallel Pipe - Swivel - (60° Cone)

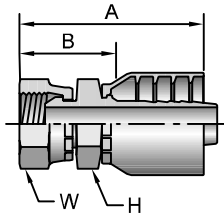

# Part Number	Thread Inch	Hose I.D. inch	A		H	W	B	
			inch	mm	mm	inch	inch	mm
1GU70-6-6	3/8x19	3/8	2.45	62	22	NA	1.55	39
1GU70-8-8	1/2x14	1/2	2.82	72	27	NA	1.61	41

## 1FG70

Male French Gaz Series - Rigid - (24° Cone)

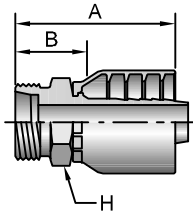

# Part Number	Thread mm	Hose I.D. inch	A		H		B	
			inch	mm	inch	mm	inch	mm
1FG70-21-10	21 M30x1,5	5/8	2.87	73	1.18	30	1.62	41

A

B

C

D

E

## 10C70

Female Metric S - Swivel - 45° Elbow - (24° Cone with O-Ring)  
ISO 12151-2 - SWE45

# Part Number	Thread mm	Hose I.D. inch	A		E		W mm	B	
			inch	mm	inch	mm		inch	mm
10C70-12-6	12 M20x1,5	3/8	2.72	69	0.79	20	24	1.57	40
10C70-16-8	16 M24x1,5	1/2	3.27	83	0.94	24	30	1.89	48
10C70-20-10	20 M30x2	5/8	3.58	91	0.98	25	36	2.05	52

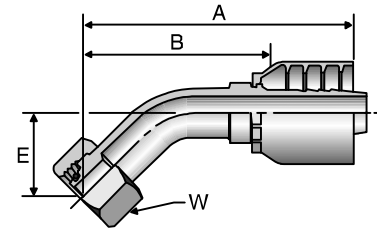

## 11C70

Female Metric S - Swivel - 90° Elbow - (24° Cone with O-Ring)  
ISO 12151-2 - SWE

# Part Number	Thread mm	Hose I.D. inch	A		E		W mm	B	
			inch	mm	inch	mm		inch	mm
11C70-12-6	12 M20X1,5	3/8	2.64	67	1.46	37	24	1.50	38
11C70-20-10	20 M30X2	5/8	3.11	79	1.89	48	36	1.57	40

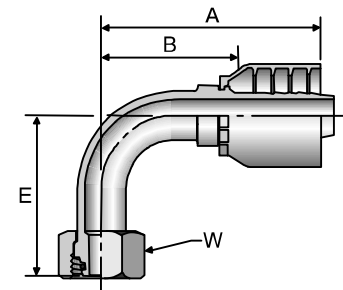

## 19270

Female BSP Parallel Pipe - Swivel - (60° Cone)  
ISO 228-1

# Part Number	Thread inch	Hose I.D. inch	A		C		W mm	B	
			inch	mm	inch	mm		inch	mm
19270-6-6	3/8x19	3/8	1.93	49	0.28	7	22	0.79	20
19270-8-8	1/2x14	1/2	2.24	57	0.28	7	27	0.87	22
19270-10-10	5/8x14	5/8	2.24	57	0.35	9	30	0.83	21
19270-12-10	3/4x14	5/8	2.40	61	0.35	9	32	0.87	22

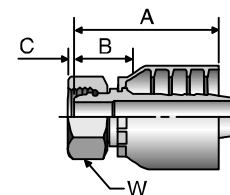

## 1B170

Female BSP Parallel pipe - Swivel- 45° Elbow - (60° Cone)  
ISO 228-1

# Part Number	Thread inch	Hose I.D. inch	A		E		W mm	B	
			inch	mm	inch	mm		inch	mm
1B170-8-8	1/2x14	1/2	3.11	79	0.79	20	27	1.77	45

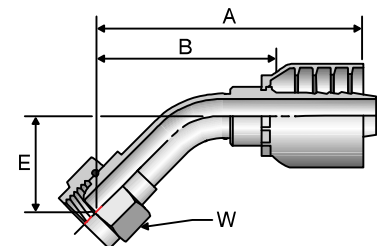

A

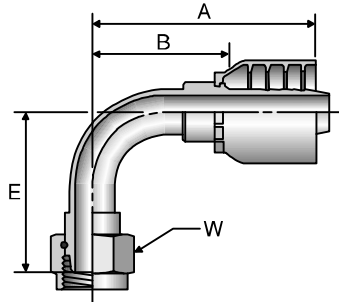

## 1B270

Female BSP Parallel Pipe - Swivel - 90° Elbow - (60° Cone)  
ISO 228-1

# Part Number	Thread inch	Hose I.D. inch	A		E		W mm	B	
			inch	mm	inch	mm		inch	mm
1B270-8-8	1/2x14	1/2	2.76	70	1.54	39	27	1.38	35
1B270-10-10	5/8x14	5/8	3.07	78	1.81	46	30	1.61	41
1B270-12-10	3/4x14	5/8	3.19	81	1.65	42	32	1.61	41

B

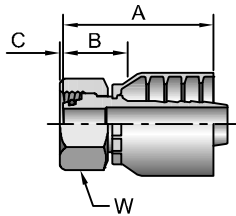

## 1C970

Female Metric S - Swivel - (24° Cone with O-Ring)

# Part Number	Thread		Hose I.D. inch	A		C		W mm	B	
	mm			inch	mm	inch	mm		inch	mm
1C970-12-6	12	M20x1,5	3/8	2.03	52	0.03	1	24	1.13	29
1C970-16-8	16	M24x1,5	1/2	2.31	59	0.09	2	30	1.10	28
1C970-20-10	20	M30x2	5/8	2.51	64	0.05	1	36	1.26	32

When measuring overall length to end of nut, B + C dimensions must be used to calculate cut-off allowance.

C

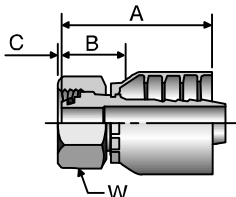

## 1CA70

Female Metric L - Swivel - (24° Cone with O-Ring)

ISO 12151-2 - SWS

# Part Number	Thread		Hose I.D. inch	A		C		W mm	B	
	mm			inch	mm	inch	mm		inch	mm
1CA70-12-6	12	M18x1,5	3/8	2.09	53	0.04	1	22	0.94	24
1CA70-15-8	15	M22x1,5	1/2	2.09	62	0.07	2	22	0.94	27
1CA70-18-10	18	M26x1,5	5/8	2.44	62	0.02	0.5	32	1.02	26

D

## 1CE70

Female Metric L - Swivel - 45° Elbow - (24° Cone with O-Ring)

ISO 12151-2 - SWE45

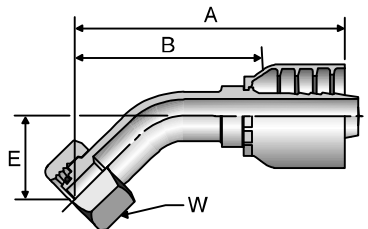

# Part Number	Thread		Hose I.D. inch	A		E		W mm	B	
	mm			inch	mm	inch	mm		inch	mm
1CE70-18-10	18	M26x1,5	5/8	3.58	91	0.98	25	32	2.05	52

E



## 1CF70

Female Metric L - Swivel - 90° Elbow - (24° Cone with O-Ring)

ISO 12151-2 - SWE

# Part Number	Thread mm	Hose I.D. inch	A		E		W mm	B	
			inch	mm	inch	mm		inch	mm
1CF70-15-8	15 M22x1,5	1/2	2.91	74	1.77	45	27	1.54	39
1CF70-18-10	18 M26x1,5	5/8	3.11	79	1.93	49	32	1.65	42

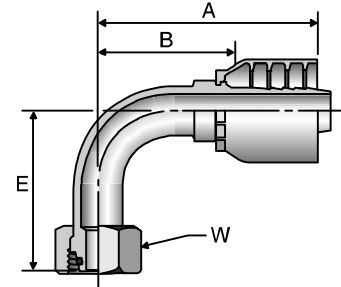

## 1D270

Male Metric S - Rigid - (24° Cone)

ISO 12151-2

# Part Number	Thread mm	Hose I.D. inch	A		H mm	B	
			inch	mm		inch	mm
1D270-16-8	16 M24x1,5	1/2	2.44	62	24	1.10	28
1D270-20-10	20 M30x2	5/8	2.95	75	30	1.26	32

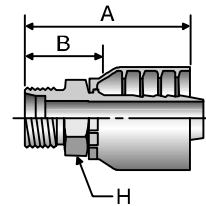

## 1D970

Male BSP Parallel Pipe - Rigid - (60° Cone)

ISO 228-1

# Part Number	Thread inch	Hose I.D. inch	A		H mm	B	
			inch	mm		inch	mm
1D970-8-8	1/2x14	1/2	2.44	62	27	1.10	28

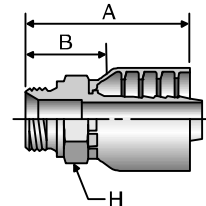

A

B

C

D

E