

Series HY

S101HY Male NPTF Pipe – Straight Rigid

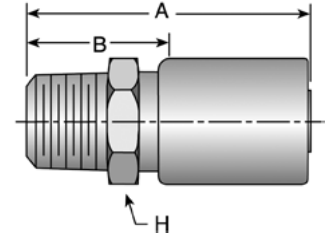

Part Number	Hose ID (in)	Thread ID (in)	Thread Dash Size	Dimensions					Std Pack Qty (per carton)	Approx Wt Per Ctn (lbs)	Stock Status **
				A (in)	A (mm)	H (in)	B (in)	B (mm)			
S101HY-2-4	1/4	1/8x27	-2	2.34	59	5/8	1.00	25	20	1.94	Y
S101HY-4-4	1/4	1/4x18	-4	2.53	64	9/16	1.19	30	25	2.73	Y
S101HY-4-6	3/8	1/4x18	-4	2.55	65	11/16	1.19	30	20	3.06	Y
S101HY-6-4	1/4	3/8x18	-6	2.53	64	3/4	1.19	30	20	2.68	Y
S101HY-6-6	3/8	3/8x18	-6	2.55	65	3/4	1.19	30	25	4.20	Y
S101HY-6-8	1/2	3/8x18	-6	2.72	69	7/8	1.38	35	20	4.54	Y
S101HY-8-6	3/8	1/2x14	-8	2.73	69	7/8	1.38	35	20	4.36	Y
S101HY-8-8	1/2	1/2x14	-8	2.91	74	7/8	1.41	40	25	6.53	Y
S101HY-8-10	5/8	1/2x14	-8	2.94	75	1-1/8	1.59	40	20	7.26	N
S101HY-8-12	3/4	1/2x14	-8	3.08	78	1-1/4	1.50	38	10	4.33	Y
S101HY-12-8	1/2	3/4x14	-12	2.91	74	1-1/16	1.56	40	20	7.60	Y
S101HY-12-10	5/8	3/4x14	-12	2.98	76	1-1/8	1.59	40	10	3.80	N
S101HY-12-12	3/4	3/4x14	-12	3.08	78	1-1/4	1.50	38	10	4.58	Y
S101HY-12-16	1	3/4x14	-12	3.23	82	1-3/8	1.63	41	10	5.40	N
S101HY-16-12	3/4	1x11-1/2	-16	3.27	83	1-3/8	1.69	43	10	5.10	Y
S101HY-16-16	1	1x11-1/2	-16	3.42	87	1-3/8	1.81	46	10	6.29	Y
S101HY-20-20	1-1/4	1-1/4 x 11-1/2	-20	3.84	98	1-3/4	2.00	51	4	6.62	Y

** Stock: "Y" indicates stocked item; "N" indicates non-stocked item. Stock status subject to change. Contact Parker Customer Service.

Couplings: Refer to CrimpSource at www.safehose.com for coupling recommendations and crimp specifications.

Series HY S102HY Female NPTF Pipe – Straight Rigid

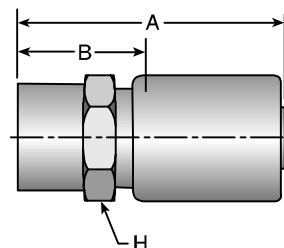

Part Number	Hose ID (in)	Thread ID (in)	Thread Dash Size	Dimensions					Std Pack Qty (per carton)	Approx Wt Per Ctn (lbs)	Stock Status **
				A (in)	A (mm)	H (in)	B (in)	B (mm)			
S102HY-2-4	1/4	1/8x27	-2	2.34	59	5/8	1.00	25	20	2.24	N
S102HY-4-4	1/4	1/4x18	-4	2.47	63	11/16	1.13	29	25	3.23	Y
S102HY-4-6	3/8	1/4x18	-4	2.48	63	11/16	1.13	29	20	2.94	N
S102HY-6-4	1/4	3/8x18	-6	2.47	63	7/8	1.13	29	20	2.94	N
S102HY-6-6	3/8	3/8x18	-6	2.48	63	7/8	1.13	29	25	4.58	N
S102HY-8-6	3/8	1/2x14	-8	2.75	70	1	1.41	36	25	5.53	N
S102HY-8-8	1/2	1/2x14	-8	2.84	72	1	1.50	38	25	6.98	N
S102HY-12-12	3/4	3/4x14	-12	2.83	72	1-1/4	1.25	32	10	4.05	N
S102HY-16-16	1	1x11-1/2	-16	3.27	83	1-1/2	1.66	42	10	6.18	N

** Stock: "Y" indicates stocked item; "N" indicates non-stocked item. Stock status subject to change. Contact Parker Customer Service.

Series HY S103HY Male JIC 37° – Straight Rigid

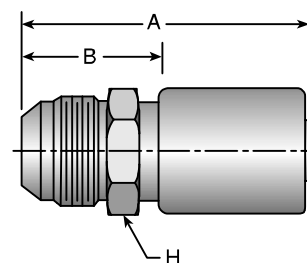

Part Number	Hose ID (in)	Thread ID (in)	Thread Dash Size	Dimensions					Std Pack Qty (per carton)	Approx Wt Per Ctn (lbs)	Stock Status **
				A (in)	A (mm)	H (in)	B (in)	B (mm)			
S103HY-4-4	1/4	7/16x20	-4	2.52	64	5/8	1.19	30	25	2.75	Y
S103HY-6-4	1/4	9/16x18	-6	2.53	64	11/16	1.19	30	20	2.68	Y
S103HY-6-6	3/8	9/16x18	-6	2.54	65	11/16	1.19	30	25	3.80	Y
S103HY-6-8	1/2	9/16x18	-6	2.72	69	7/8	1.38	35	25	5.50	N
S103HY-8-6	3/8	3/4x16	-8	2.64	67	13/16	1.28	33	20	3.96	Y
S103HY-8-8	1/2	3/4x16	-8	2.81	71	5/8	1.47	37	25	6.10	Y
S103HY-10-8	1/2	7/8x14	-10	2.91	74	1	1.56	40	20	5.60	Y
S103HY-10-10	5/8	7/8x14	-10	2.98	76	1-1/8	1.59	40	25	9.08	N
S103HY-10-12	3/4	7/8x14	-10	3.08	78	1-1/4	1.50	38	5	2.23	N
S103HY-12-8	1/2	1-1/16x12	-12	3.02	77	1-1/8	1.66	42	25	8.98	N
S103HY-12-10	5/8	1-1/16x12	-12	3.09	78	1-1/8	1.72	44	25	9.65	N
S103HY-12-12	3/4	1-1/16x12	-12	3.19	81	1-1/4	1.63	41	10	4.60	Y
S103HY-16-12	3/4	1-5/16x12	-16	3.23	82	1-3/8	1.66	42	10	5.29	N
S103HY-16-16	1	1-5/16x12	-16	3.39	86	1-3/8	1.78	45	10	6.44	N

** Stock: "Y" indicates stocked item; "N" indicates non-stocked item. Stock status subject to change. Contact Parker Customer Service.

Couplings: Refer to CrimpSource at www.safehose.com for coupling recommendations and crimp specifications.



Series HY

S106HY Female JIC 37° – Straight Swivel

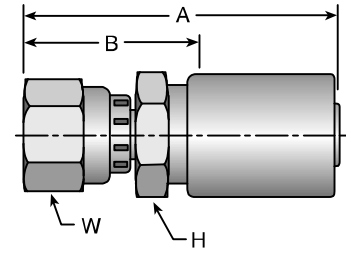

Part Number	Hose ID (in)	Thread ID (in)	Thread Dash Size	Dimensions						Std Pack Qty (per carton)	Approx Wt Per Ctn (lbs)	Stock Status **
				A (in)	A (mm)	H (in)	W (in)	B (in)	B (mm)			
S106HY-4-4	1/4	7/16x20	-4	2.60	66	9/16	9/16	1.25	32	25	3.18	Y
S106HY-4-6	3/8	7/16x20	-4	2.67	68	3/4	9/16	1.31	33	20	3.30	Y
S106HY-5-4	1/4	1/2x20	-5	2.65	67	9/16	5/8	1.31	33	20	2.52	Y
S106HY-6-4	1/4	9/16x18	-6	2.67	68	5/8	11/16	1.31	33	20	2.62	Y
S106HY-6-6	3/8	9/16x18	-6	2.69	68	11/16	11/16	1.34	34	50	8.35	Y
S106HY-6-8	1/2	9/16x18	-6	2.86	73	7/8	9/16	1.50	38	20	4.80	N
S106HY-8-6	3/8	3/4x16	-8	2.72	69	7/8	7/8	1.38	35	20	3.96	Y
S106HY-8-8	1/2	3/4x16	-8	2.90	74	7/8	7/8	1.56	40	50	13.20	Y
S106HY-8-10	5/8	3/4x16	-8	2.98	76	1-1/8	7/8	1.59	40	20	7.06	N
S106HY-8-12	3/4	3/4x16	-8	3.08	78	1-1/4	7/8	1.53	39	10	2.64	N
S106HY-10-8	1/2	7/8x14	-10	2.98	76	1	1	1.63	41	20	6.20	Y
S106HY-10-10	5/8	7/8x14	-10	3.06	78	1-1/8	1	1.69	43	25	9.95	Y
S106HY-10-12	3/4	7/8x14	-10	3.16	80	1-1/4	1	1.59	40	10	5.23	N
S106HY-12-8	1/2	1-1/16x12	-12	3.05	77	1-1/8	1-1/4	1.69	43	10	3.84	Y
S106HY-12-10	5/8	1-1/16x12	-12	3.12	79	1-1/8	1-1/4	1.75	44	10	4.48	Y
S106HY-12-12	3/4	1-1/16x12	-12	3.22	82	1-1/4	1-1/4	1.66	42	25	13.08	Y
S106HY-12-16	1	1-1/16x12	-12	3.38	86	1-3/8	1-1/4	1.75	44	10	6.40	N
S106HY-16-16	1	1-5/16x12	-16	3.45	88	1-3/8	1-1/2	1.84	47	10	6.86	Y
S106HY-20-20	1-1/4	1-5/8x12	-20	4.09	104	2	2	2.25	57	4	5.00	Y

** Stock: "Y" indicates stocked item; "N" indicates non-stocked item. Stock status subject to change. Contact Parker Customer Service.

Series HY

S107HY Female NPSM Pipe – Straight Swivel

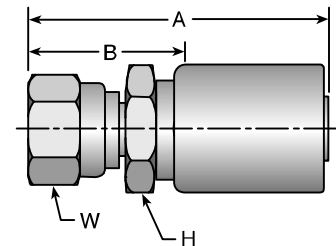

Part Number	Hose ID (in)	Thread ID (in)	Thread Dash Size	Dimensions						Std Pack Qty (per carton)	Approx Wt Per Ctn (lbs)	Stock Status **
				A (in)	A (mm)	H (in)	W (in)	B (in)	B (mm)			
S107HY-4-4	1/4	1/4x18	-4	2.66	68	9/16	11/16	1.31	33	20	2.76	N
S107HY-6-6	3/8	3/8x18	-6	2.55	65	3/4	7/8	1.19	30	25	5.25	Y
S107HY-8-8	1/2	1/2x14	-8	2.91	74	3/4	1	1.56	40	25	7.55	N

** Stock: "Y" indicates stocked item; "N" indicates non-stocked item. Stock status subject to change. Contact Parker Customer Service.

Couplings: Refer to CrimpSource at www.safehose.com for coupling recommendations and crimp specifications.

Parker Industrial Hose Customer Service
866 810 HOSE (4673) 800 242 HOSE (4673)
Strongsville, OH South Gate, CA
Eastern USA Western USA

www.safehose.com
e-mail: indhose@parker.com

Series HY

S113HY Male NPTF Pipe – Straight Swivel

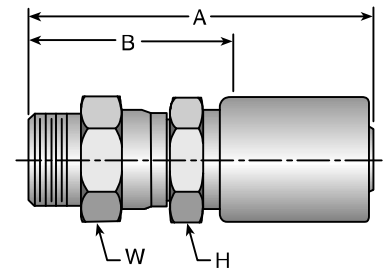

Part Number	Hose ID (in)	Thread ID (in)	Thread Dash Size	Dimensions						Std Pack Qty (per carton)	Approx Wt Per Ctn (lbs)	Stock Status **
				A (in)	A (mm)	H (in)	W (in)	B (in)	B (mm)			
S113HY-4-4	1/4	1/4x18	-4	3.06	78	9/16	5/8	1.72	44	25	2.95	Y
S113HY-6-6	3/8	3/8x18	-6	3.11	79	11/16	11/16	1.75	44	25	6.23	Y
S113HY-8-8	1/2	1/2x14	-8	3.50	89	7/8	7/8	2.16	55	25	8.55	Y
S113HY-12-12	3/4	3/4x14	-12	3.95	100	1-1/4	1-1/4	2.38	60	10	7.50	Y
S113HY-16-16	1	1x11-1/2	-16	4.23	107	1-1/2	1-1/2	2.63	67	10	11.52	Y

** Stock: "Y" indicates stocked item; "N" indicates non-stocked item. Stock status subject to change. Contact Parker Customer Service.

Series HY

S139HY Female JIC 37° – 90° Swivel Short Drop Elbow

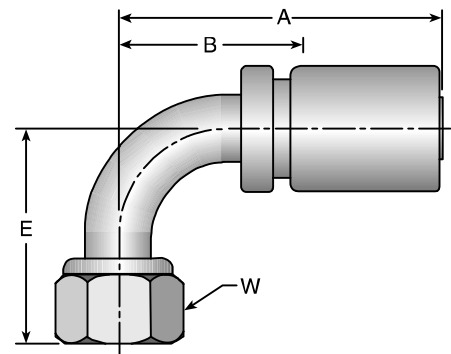

Part Number	Hose ID (in)	Thread ID (in)	Thread Dash Size	Dimensions						Std Pack Qty (per carton)	Approx Wt Per Ctn (lbs)	Stock Status **	
				A (in)	A (mm)	E (in)	E (mm)	W (in)	B (in)				B (mm)
S139HY-4-4	1/4	7/16x20	-4	2.40	61	0.83	21	9/16	1.13	29	10	1.47	Y
S139HY-6-4	1/4	9/16x18	-6	2.65	67	0.91	23	3/4	1.38	35	10	1.63	Y
S139HY-6-6	3/8	9/16x18	-6	2.57	65	0.91	23	11/16	1.29	33	10	2.17	Y
S139HY-8-6	3/8	3/4x16	-8	2.64	67	1.14	29	7/8	1.37	35	10	2.70	Y
S139HY-8-8	1/2	3/4x16	-8	2.85	72	1.14	29	7/8	1.56	40	10	3.60	Y
S139HY-10-8	1/2	7/8x14	-10	3.01	76	1.26	32	1	1.72	44	10	3.72	Y
S139HY-10-10	5/8	7/8x14	-10	3.09	78	1.26	32	1	1.73	44	10	4.73	N
S139HY-12-8	1/2	1-1/16x12	-12	3.61	92	1.83	46	1-1/4	2.25	57	10	7.00	N
S139HY-12-10	5/8	1-1/16x12	-12	3.61	92	1.89	48	1-1/4	2.25	57	10	7.00	N
S139HY-12-12	3/4	1-1/16x12	-12	3.68	93	1.89	48	1-1/4	2.15	55	5	3.50	Y
S139HY-16-12	3/4	1-5/16x12	-16	4.33	110	2.14	54	1-1/2	2.78	71	5	4.30	N
S139HY-16-16	1	1-5/16x12	-16	4.31	109	2.31	59	1-1/2	2.69	68	5	4.78	Y

** Stock: "Y" indicates stocked item; "N" indicates non-stocked item. Stock status subject to change. Contact Parker Customer Service.

Couplings: Refer to CrimpSource at www.safehose.com for coupling recommendations and crimp specifications.

