











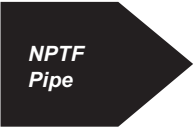
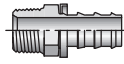
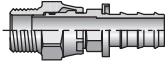





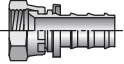
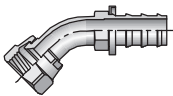
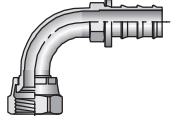
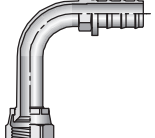

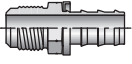

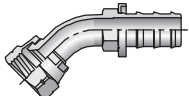
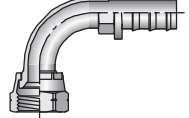

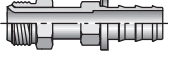
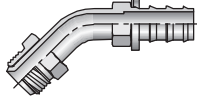
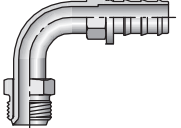
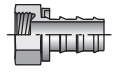

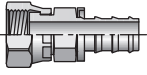
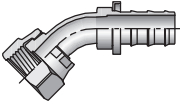
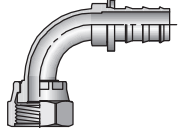
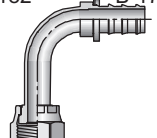

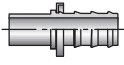

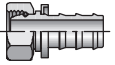

Hose  
A

Fittings 82 Series  
B

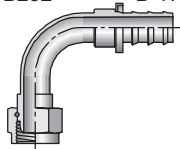
Equipment  
C

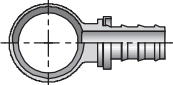
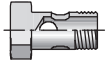
Accessories  
D

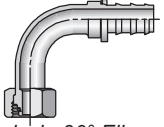
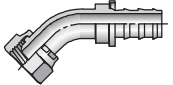
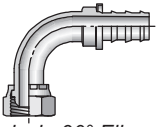
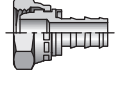
Technical  
E

 <b>NPTF Pipe</b>	30182 B-168  <i>Male - Rigid</i>	31382 B-168  <i>Male - Swivel</i>	30282 B-169  <i>Female - Rigid</i>	 <b>NPSM Pipe</b>	37G82 B-169  <i>Female - Swivel Gasket Joint</i>
 <b>JIC 37°</b>	30382 B-169  <i>Male - Rigid</i>	30682 B-170  <i>Female - Swivel</i>	33782 B-170  <i>Female - Swivel 45° Elbow - Short</i>	33982 B-170  <i>Female - Swivel 90° Elbow - Short</i>	34182 B-170  <i>Female - Swivel 90° Elbow - Long</i>
 <b>SAE</b>	30482 B-171  <i>Male - Rigid</i>	30882 B-171  <i>Female - Swivel</i>	37782 B-171  <i>Female - Swivel 45° Elbow</i>	37982 B-171  <i>Female - Swivel 90° Elbow</i>	 <b>Inverted SAE</b>
32882 B-172  <i>Male - Swivel</i>	36782 B-172  <i>Male - Swivel 45° Elbow</i>	36982 B-172  <i>Male - Swivel 90° Elbow</i>	32982 B-172  <i>Female - Rigid</i>	 <b>Seal-Lok® O-Ring Face Seal</b>	3JC82 B-173  <i>Female - Swivel Short</i>
3J782 B-173  <i>Female - Swivel 45° Elbow</i>	3J982 B-173  <i>Female - Swivel 90° Elbow - Short</i>	3J182 B-173  <i>Female - Swivel 90° Elbow - Long</i>	 <b>Standpipe</b>	33482 B-174  <i>Male - Rigid</i>	 <b>Union</b>
38282 B-174  <i>Push-Lok Union</i>	 <b>Metric L</b>	3D082 B-174  <i>Male - Rigid</i>	31D82 B-175  <i>Male Standpipe Rigid</i>	 <b>BSP</b>	39282 B-175  <i>Female - Swivel</i>
3D982 B-175  <i>Male - Rigid</i>	3B282 B-175  <i>Female - Swivel 90° Elbow</i>	 <b>Banjo</b>	34982 B-176  <i>Metric - Banjo</i>	AM B-176  <i>Banjo Bolt</i>	 <b>Metric L Swivels</b>
3CA82 B-177  <i>Swivel - 24° Cone</i>	3CF82 B-177  <i>Swivel - 90° Elbow - 24° Cone</i>	3C482 B-177  <i>Swivel - 45° Elbow - Ball Nose</i>	3C582 B-178  <i>Swivel - 90° Elbow - Ball Nose</i>	3C382 B-178  <i>Swivel - Ball Nose</i>	 <b>Kits</b>

Push-Lok Kits B-179  <i>Push-Lok Hose and Fitting Kits</i>	Push-Lok Merchandiser B-180  <i>Push-Lok Hose and Fitting Display Case</i>	 <p><b>Assembly Instructions</b></p>	82 Series Assembly Instructions B-181
---	---	---	--

Hose  
**A**

Fittings 82 Series  
**B**

Equipment  
**C**

Accessories  
**D**

Technical  
**E**

Hose  
**A**

Fittings 82 Series  
**B**

Equipment  
**C**

Accessories  
**D**

Technical  
**E**

### 30182 Male NPTF Pipe - Rigid

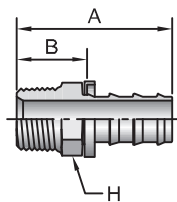

# Part Number	Thread inch	Hose I.D. inch	A		H inch	B		Additional Material	
			inch	mm		inch	mm	Brass (B)	Stainless Steel (C)
30182-2-4	1/8x27	1/4	1.39	35	7/16	0.64	16	•	•
30182-4-4	1/4x18	1/4	1.57	40	9/16	0.82	21	•	•
30182-4-6	1/4x18	3/8	1.78	45	9/16	0.88	22	•	•
30182-4-8	1/4x18	1/2	1.93	49	5/8	0.88	22	•	•
30182-6-6	3/8x18	3/8	1.78	45	11/16	0.88	22	•	•
30182-6-8	3/8x18	1/2	1.93	49	11/16	0.88	22	•	•
30182-8-6	1/2x14	3/8	2.03	52	7/8	1.13	29	•	•
30182-8-8	1/2x14	1/2	2.18	55	7/8	1.13	29	•	•
30182-8-10	1/2x14	5/8	2.58	66	7/8	1.13	29	•	•
30182-8-12	1/2x14	3/4	2.58	66	7/8	1.13	29	•	•
30182-12-8	3/4x14	1/2	2.21	56	3/4	1.16	29	•	•
30182-12-10	3/4x14	5/8	2.61	66	1-1/16	1.16	29	•	•
30182-12-12	3/4x14	3/4	2.61	66	1-1/16	1.16	29	•	•
30182-16-16	1x11-1/2	1	3.06	78	1-3/8	1.61	41	•	•

### 31382 Male NPTF Pipe - Swivel

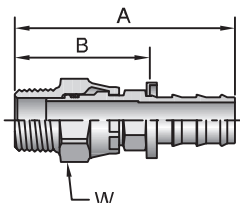

# Part Number	Thread inch	Hose I.D. inch	A		W inch	B		Additional Material Brass (B)
			inch	mm		inch	mm	
31382-4-4	1/4x18	1/4	1.60	41	9/16	0.85	22	
31382-6-6	3/8x18	3/8	1.79	45	11/16	0.89	23	
31382-8-8	1/2x14	1/2	2.20	56	7/8	1.15	29	
31382-8-10	1/2x14	5/8	3.50	90	7/8	2.05	52	•
31382-12-12	3/4x14	3/4	3.70	94	1-1/4	2.25	57	

O-Ring not compatible with Phosphate Ester fluids.

### 30282

#### Female NPTF Pipe - Rigid

# Part Number	Thread inch	Hose I.D. inch	A		H inch	B		Additional Material Brass (B)
			inch	mm		inch	mm	
30282-4-4	1/4x18	1/4	1.56	40	3/4	0.81	21	•
30282-6-6	3/8x18	3/8	1.82	46	7/8	0.92	23	•
30282-8-8	1/2x14	1/2	2.16	55	1-1/16	1.11	28	•

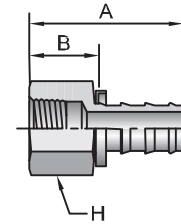

### 37G82

#### Female NPSM Pipe - Gasket Joint - Swivel

# Part Number	Gasket	Thread inch	Hose I.D. inch	A		W inch	B	
				inch	mm		inch	mm
37G82-4-4	07G-4	1/4x18	1/4	1.55	39	11/16	0.80	20
37G82-4-6	07G-4	1/4x18	3/8	1.70	43	11/16	0.80	20
37G82-6-6	07G-6	3/8x18	3/8	1.75	44	7/8	0.85	22
37G82-8-8	07G-8	1/2x14	1/2	2.07	53	1	1.02	26
37G82-8-10	07G-8	1/2x14	5/8	2.47	63	1	1.02	26
37G82-12-12	07G-12	3/4x14	3/4	2.54	65	1-1/4	1.09	28

Textile gasket included with fitting.

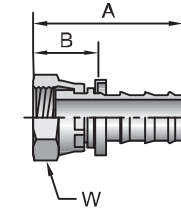

### 30382

#### Male JIC 37° - Rigid

# Part Number	Thread inch	Hose I.D. inch	A		H inch	B		Additional Material Brass (B)
			inch	mm		inch	mm	
30382-4-4	1/4 7/16x20	1/4	1.56	40	1/2	0.81	21	
30382-5-4	5/16 1/2x20	1/4	1.59	40	9/16	0.84	21	
30382-6-6	3/8 9/16x18	3/8	1.78	45	5/8	0.88	22	•
30382-8-8	1/2 3/4x16	1/2	2.06	52	3/4	1.01	26	
30382-10-10	5/8 7/8x14	5/8	2.62	67	7/8	1.17	30	
30382-12-12	3/4 1-1/16x12	3/4	2.72	69	1-1/8	1.27	32	

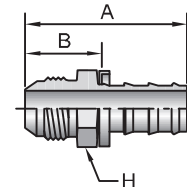

Hose  
**A**

Fittings 82 Series  
**B**

Equipment  
**C**

Accessories  
**D**

Technical  
**E**

### 30682

Female JIC 37° - Swivel

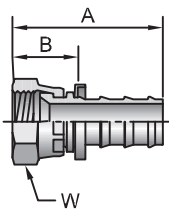

# Part Number	Thread		Hose I.D. inch	A		W inch	B		Additional Material	
	inch	mm		inch	mm		inch	mm	Brass (B)	Stainless Steel (C)
30682-4-4	1/4	7/16x20	1/4	1.52	39	9/16	0.77	20	•	•
30682-5-4	5/16	1/2x20	1/4	1.58	40	5/8	0.83	21	•	
30682-5-6	5/8	1/2x20	3/8	1.72	44	5/8	0.82	21	•	
30682-6-4	3/8	9/16x18	1/4	1.61	41	11/16	0.86	22	•	
30682-6-6	3/8	9/16x18	3/8	1.75	44	11/16	0.85	22	•	•
30682-6-8	3/8	9/16x18	1/2	1.90	48	11/16	0.85	22	•	
30682-8-6	1/2	3/4x16	3/8	1.87	47	7/8	0.97	25	•	
30682-8-8	1/2	3/4x16	1/2	2.02	51	7/8	0.97	25	•	•
30682-10-8	5/8	7/8x14	1/2	2.14	54	1	1.09	28	•	
30682-10-10	5/8	7/8x14	5/8	2.54	65	1	1.09	28	•	•
30682-12-12	3/4	1-1/16x12	3/4	2.65	67	1-1/4	1.20	30	•	•
30682-16-16	1	1-5/16x12	1	2.77	70	1-3/8	1.32	34	•	

### 33782

Female JIC 37° - Swivel - 45° Elbow - Short Drop

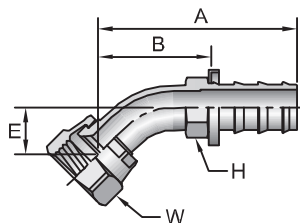

# Part Number	Thread		Hose I.D. inch	A		E		H inch	W inch	B	
	inch	mm		inch	mm	inch	mm			inch	mm
33782-4-4	1/4	7/16x20	1/4	1.74	44	0.39	10	7/16	9/16	0.99	25
33782-6-6	3/8	9/16x18	3/8	1.99	51	0.43	11	1/2	11/16	1.09	28
33782-8-8	1/2	3/4x16	1/2	2.58	66	0.55	14	5/8	7/8	1.53	39
33782-10-10	5/8	7/8x14	5/8	3.03	77	0.65	17	3/4	1	1.58	40

### 33982

Female JIC 37° - Swivel - 90° Elbow - Short Drop

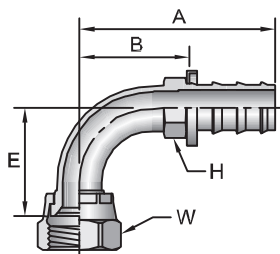

# Part Number	Thread		Hose I.D. inch	A		E		H inch	W inch	B	
	inch	mm		inch	mm	inch	mm			inch	mm
33982-4-4	1/4	7/16x20	1/4	1.55	39	0.83	21	---	9/16	0.80	20
33982-6-6	3/8	9/16x18	3/8	1.85	47	0.91	23	---	11/16	0.95	24
33982-8-8	1/2	3/4x16	1/2	2.33	59	1.09	28	5/8	7/8	1.28	33
33982-10-10	5/8	7/8x14	5/8	2.88	73	1.24	31	3/4	1	1.43	36
33982-12-12	3/4	1-1/16x12	3/4	3.26	83	1.81	46	7/8	1-1/4	1.81	46

### 34182

Female JIC 37° - Swivel - 90° Elbow - Long Drop

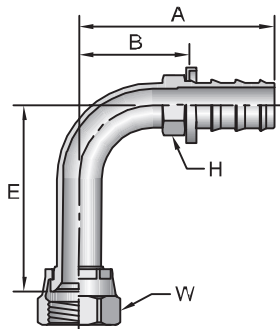

# Part Number	Thread		Hose I.D. inch	A		E		H inch	W inch	B	
	inch	mm		inch	mm	inch	mm			inch	mm
34182-4-4	1/4	7/16x20	1/4	1.79	45	1.80	46	7/16	9/16	1.04	26
34182-6-6	3/8	9/16x18	3/8	1.97	50	2.18	55	1/2	11/16	1.07	27

### 30482

Male SAE 45° - Rigid

# Part Number	Thread		Hose I.D. inch	A		H inch	B	
	inch	mm		inch	mm		inch	mm
30482-4-4B	1/4	7/16x20	1/4	1.51	38	7/16	0.76	19
30482-5-4B	5/16	1/2x20	1/4	1.61	41	9/16	0.86	22
30482-6-6B	3/8	5/8x18	3/8	1.84	47	5/8	0.94	24
30482-8-8B	1/2	3/4x16	1/2	2.15	55	3/4	1.10	28

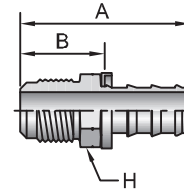

### 30882

Female SAE 45° - Swivel

# Part Number	Thread		Hose I.D. inch	A		W inch	B		Additional Material Brass (B)
	inch	mm		inch	mm		inch	mm	
30882-4-4	1/4	7/16x20	1/4	1.52	39	9/16	0.77	20	•
30882-5-4	5/16	1/2x20	1/4	1.58	40	5/8	0.83	21	•
30882-6-6	3/8	5/8x18	3/8	1.81	46	3/4	0.91	23	•
30882-8-6	1/2	3/4x16	3/8	1.87	47	7/8	0.97	25	•
30882-8-8	1/2	3/4x16	1/2	2.02	51	7/8	0.97	25	•
30882-10-10	5/8	7/8x14	5/8	2.54	65	1	1.09	28	•
30882-12-12	3/4	1-1/16x14	3/4	2.65	67	1-1/4	1.20	30	•

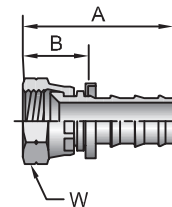

### 37782

Female SAE 45° - Swivel - 45° Elbow

# Part Number	Thread		Hose I.D. inch	A		E		H inch	W inch	B	
	inch	mm		inch	mm	inch	mm			inch	mm
37782-4-4	1/4	7/16x20	1/4	1.79	45	0.33	8	7/16	9/16	1.04	26
37782-6-6	3/8	5/8x18	3/8	2.08	53	0.39	10	1/2	3/4	1.18	30
37782-8-8	1/2	3/4x16	1/2	2.58	66	0.55	14	5/8	7/8	1.53	39

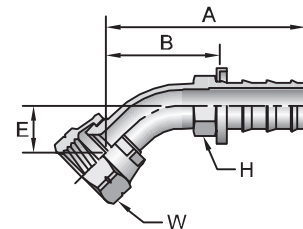

### 37982

Female SAE 45° - Swivel - 90° Elbow

# Part Number	Thread		Hose I.D. inch	A		E		H inch	W inch	B	
	inch	mm		inch	mm	inch	mm			inch	mm
37982-4-4	1/4	7/16x20	1/4	1.60	41	0.83	21	7/16	9/16	0.85	22
37982-6-6	3/8	5/8x18	3/8	1.98	50	0.85	22	1/2	3/4	1.08	27
37982-8-8	1/2	3/4x16	1/2	2.33	59	1.09	28	5/8	7/8	1.28	33

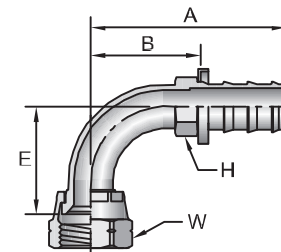

Notch in nut signifies 45° flare.

Hose  
A

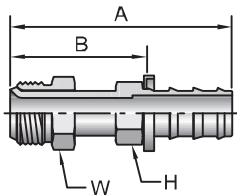

### 32882

#### Male Inverted SAE 45° - Swivel

# Part Number	Thread		Hose I.D. inch	A		H inch	W inch	B	
	inch	inch		inch	mm			inch	mm
32882-3-4	3/16	3/8x24	1/4	2.15	55	3/8	3/8	1.40	36
32882-4-4	1/4	7/16x24	1/4	2.15	55	7/16	7/16	1.40	36
32882-5-4	5/16	1/2x20	1/4	2.31	59	7/16	1/2	1.56	40
32882-6-6	3/8	5/8x18	3/8	2.58	66	1/2	5/8	1.68	43
32882-8-8	1/2	3/4x18	1/2	2.82	72	5/8	3/4	1.77	45
32882-10-10	5/8	7/8x18	5/8	3.34	85	3/4	7/8	1.89	48

Fittings 82 Series  
B

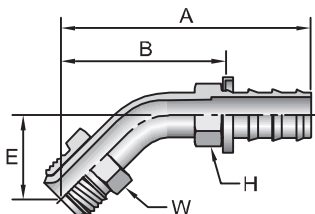

### 36782

#### Male Inverted SAE 45° - Swivel - 45° Elbow

# Part Number	Thread		Hose I.D. inch	A		E		H inch	W inch	B	
	inch	inch		inch	mm	inch	mm			inch	mm
36782-4-4	1/4	7/16x24	1/4	1.92	49	0.63	16	7/16	7/16	1.17	30
36782-6-6	3/8	5/8x18	3/8	2.64	67	0.94	24	1/2	5/8	1.74	44

Equipment  
C

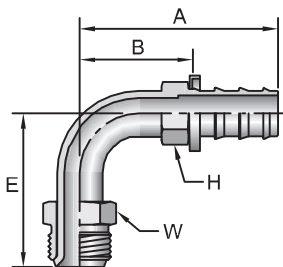

### 36982

#### Male Inverted SAE 45° - Swivel - 90° Elbow

# Part Number	Thread		Hose I.D. inch	A		E		H inch	W inch	B	
	inch	inch		inch	mm	inch	mm			inch	mm
36982-4-4	1/4	7/16x24	1/4	1.99	51	1.56	40	7/16	7/16	1.24	31
36982-5-4	5/16	1/2x20	1/4	2.17	55	1.65	42	7/16	1/2	1.42	36
36982-6-6	3/8	5/8x18	3/8	2.30	58	1.69	43	1/2	5/8	1.40	36

Accessories  
D

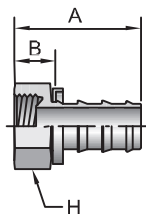

### 32982

#### Female Inverted SAE 45° - Rigid

# Part Number	Thread		Hose I.D. inch	A		H inch	B	
	inch	inch		inch	mm		inch	mm
32982-4-4B	1/4	7/16x24	1/4	1.19	30	1/2	0.44	11
32982-5-4B	5/16	1/2x20	1/4	1.25	32	9/16	0.50	13
32982-6-6B	3/8	5/8x18	3/8	1.44	37	3/4	0.54	14
32982-8-8B	1/2	3/4x18	1/2	1.62	41	7/8	0.57	14

Technical  
E

### 3JC82

Female Seal-Lok® - Swivel - Short  
ISO 12151-1 - SWSA

# Part Number	Thread		Hose I.D. inch	A		C		H inch	W inch	B		Additional Material	
	inch	9/16x18		inch	mm	inch	mm			inch	mm	Brass (B)	Stainless Steel (C)
3JC82-4-4	1/4	9/16x18	1/4	1.40	36	0.32	8	9/16	11/16	0.65	17		•
3JC82-6-6	3/8	11/16x16	3/8	1.59	40	0.38	10	11/16	13/16	0.69	18		•
3JC82-6-6SM	3/8	11/16x16	3/8	1.59	40	0.38	10	19mm	22mm	0.69	18		
3JC82-8-6	1/2	13/16x16	3/8	1.65	42	0.38	10	13/16	15/16	0.76	19		
3JC82-8-8	1/2	13/16x16	1/2	1.80	46	0.43	11	13/16	15/16	0.75	19		•
3JC82-10-10	5/8	1x14	5/8	2.40	61	0.53	13	15/16	1-1/8	0.95	24		
3JC82-12-12	3/4	1-3/16x12	3/4	2.63	67	0.57	14	1-1/8	1-3/8	1.18	30		•
3JC82-16-16	1	1-7/16x12	1	2.61	66	0.58	15	1-3/8	1-5/8	1.16	29	•	•

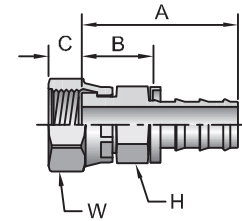

When measuring overall length to the end of the nut, B+C dimensions must be used to calculate cut-off allowance.

### 3J782

Female Seal-Lok® - Swivel - 45° Elbow  
ISO 12151-1 - SWE45

# Part Number	Thread		Hose I.D. inch	A		E		W inch	B	
	inch	9/16x18		inch	mm	inch	mm		inch	mm
3J782-4-4	1/4	9/16x18	1/4	1.74	44	0.39	10	11/16	0.99	25
3J782-6-6	3/8	11/16x16	3/8	1.99	51	0.43	11	13/16	1.09	28
3J782-8-8	1/2	13/16x16	1/2	2.41	61	0.59	15	15/16	1.36	35

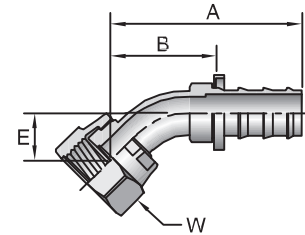

### 3J982

Female Seal-Lok® - Swivel - 90° Elbow - Short Drop  
ISO 12151-1 - SWES90

# Part Number	Thread		Hose I.D. inch	A		E		W inch	B	
	inch	9/16x18		inch	mm	inch	mm		inch	mm
3J982-4-4	1/4	9/16x18	1/4	1.55	39	0.83	21	11/16	0.80	20
3J982-6-6	3/8	11/16x16	3/8	1.85	47	0.91	23	13/16	0.95	24
3J982-6-8	3/8	11/16x16	1/2	2.09	53	0.91	23	13/16	1.04	26
3J982-8-6	1/2	13/16x16	3/8	1.94	49	1.14	29	15/16	1.04	26
3J982-8-8	1/2	13/16x16	1/2	2.16	55	1.14	29	15/16	1.11	28
3J982-10-10	5/8	1x14	5/8	2.76	70	1.26	32	1-1/8	1.31	33
3J982-12-12	3/4	1-3/6x12	3/4	3.27	83	1.89	48	1-3/8	1.82	46

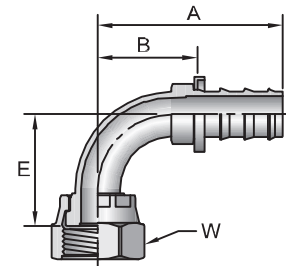

### 3J182

Female Seal-Lok® - Swivel - 90° Elbow - Long Drop  
ISO 12151-1 - SWEL90

# Part Number	Thread		Hose I.D. inch	A		E		W inch	B	
	inch	11/16x16		inch	mm	inch	mm		inch	mm
3J182-6-6	3/8	11/16x16	3/8	1.85	47	2.13	54	13/16	0.95	24
3J182-8-8	1/2	13/16x16	1/2	2.16	55	2.52	64	15/16	1.11	28

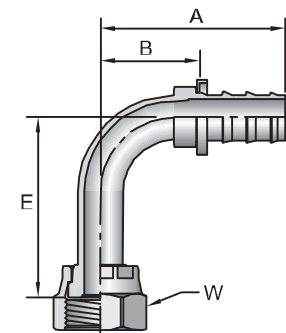

See Accessories for O-Rings.

Hose  
A

Fittings 82 Series  
B

Equipment  
C

Accessories  
D

Technical  
E



Hose  
**A**

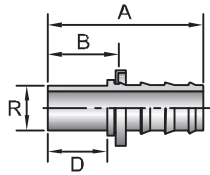

### 33482

#### Male Standpipe - Rigid - (Inch Size Tube O.D.)

# Part Number	R inch	Hose I.D. inch	A		D		B		Additional Material	
			inch	mm	inch	mm	inch	mm	Brass (B)	Stainless Steel (C)
33482-4-4	1/4	1/4	1.89	48	1.02	26	1.14	29	•	•
33482-5-4	5/16	1/4	1.93	49	1.08	27	1.18	30	•	•
33482-6-6	3/8	3/8	2.23	57	1.22	31	1.33	34	•	•
33482-8-8	1/2	1/2	2.16	55	0.97	25	1.11	28	•	•
33482-10-10	5/8	5/8	2.62	67	1.00	25	1.17	30	•	•
33482-12-12	3/4	3/4	2.62	67	1.00	25	1.17	30	•	•

Fittings 82 Series  
**B**

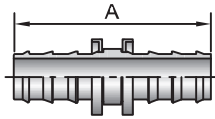

### 38282

#### Push-Lok Union

# Part Number	Hose I.D. inch	A		Additional Material Brass (B)
		inch	mm	
38282-4-4	1/4	1.80	46	•
38282-6-6	3/8	2.15	55	•
38282-8-8	1/2	2.51	64	•
38282-10-10	5/8	3.31	84	•
38282-12-12	3/4	3.31	84	•
38282-16-16	1	3.31	84	•

Equipment  
**C**

### 3D082

#### Male Metric L - Rigid - (24° Cone)

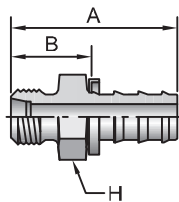

# Part Number	Thread		Hose I.D. inch	A		H mm	B	
	mm			inch	mm		inch	mm
3D082-6-4	6	M12x1,5	1/4	1.34	34	12	0.55	14
3D082-8-4	8	M14x1,5	1/4	1.38	35	14	0.59	15
3D082-10-6	10	M16x1,5	3/8	1.57	40	17	0.63	16
3D082-12-6	12	M18x1,5	3/8	1.61	41	19	0.67	17

Accessories  
**D**

Technical  
**E**

### 31D82 Male Standpipe Metric L - Rigid

# Part Number	R mm	Hose I.D. inch	A		D		B	
			inch	mm	inch	mm	inch	mm
31D82-6-4	6	1/4	1.73	44	0.87	22	0.98	25
31D82-8-4	8	1/4	1.73	44	0.87	22	0.98	25
31D82-10-6	10	3/8	1.93	49	0.91	23	1.02	26
31D82-12-6	12	3/8	1.93	49	0.91	23	1.06	27
31D82-15-8	15	1/2	2.17	55	0.98	25	1.10	28
31D82-18-10	18	5/8	2.64	67	1.02	26	1.10	28
31D82-22-12	22	3/4	2.72	69	1.10	28	1.22	31

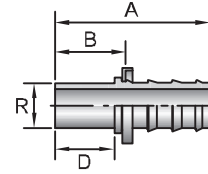

### 39282 Female BSP Parallel Pipe - Swivel - (60° Cone)

# Part Number	Thread inch	Hose I.D. inch	A		C		W mm	B		Additional Material Brass (B)
			inch	mm	inch	mm		inch	mm	
39282-4-4	1/4x19	1/4	1.34	34	0.22	6	17	0.55	14	
39282-6-6	3/8x19	3/8	1.50	38	0.26	7	19	0.55	14	•
39282-8-8	1/2x14	1/2	1.77	45	0.28	7	27	1.06	27	
39282-12-12	3/4x14	3/4	2.13	54	0.35	9	36	1.42	36	

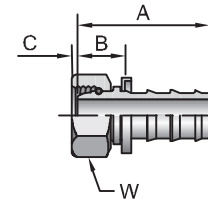

When measuring overall length to the end of the nut, B + C dimensions must be used to calculate cut-off allowances.

### 3D982 Male BSP Parallel Pipe - Rigid - (60° Cone)

# Part Number	Hose I.D. inch	A		H mm	B	
		inch	mm		inch	mm
3D982-2-4	1/4	1.42	36	14	0.63	16
3D982-4-4	1/4	1.61	41	19	0.83	21
3D982-4-6	3/8	1.77	45	19	0.83	21
3D982-6-6	3/8	1.77	45	22	0.87	22
3D982-8-8	1/2	2.09	53	27	0.98	25
3D982-8-10	5/8	2.44	62	27	0.94	24
3D982-12-12	3/4	2.56	65	32	1.06	27

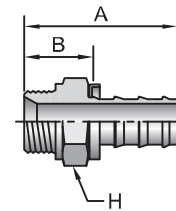

Bonded seal required if fitting is used directly in a port. See Accessories Section.

### 3B282 Female BSP Parallel Pipe - Swivel - 90° Elbow - (60° Cone)

# Part Number	Thread inch	Hose I.D. inch	A		E		W mm	B	
			inch	mm	inch	mm		inch	mm
3B282-4-4	1/4x19	1/4	1.65	42	1.02	26	17	1.02	26
3B282-6-6	3/8x19	3/8	2.09	53	1.18	30	19	1.18	30
3B282-8-8	1/2x14	1/2	2.56	65	1.57	40	27	1.57	40
3B282-10-10	5/8x14	5/8	2.99	76	1.57	40	30	1.57	40

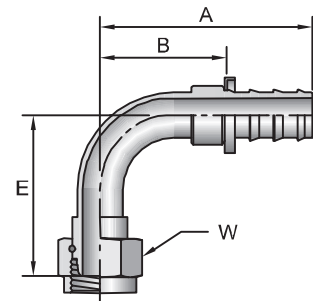

Hose  
**A**

Fittings 82 Series  
**B**

Equipment  
**C**

Accessories  
**D**

Technical  
**E**

### 34982 DIN Metric Banjo

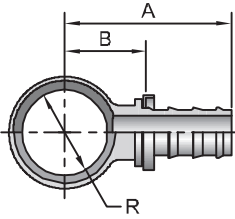

# Part Number	R		Hose I.D.		A		B	
	mm	inch	inch	mm	inch	mm		
34982-8-4	8	1/4	1.42	36	0.63	16		
34982-10-4	10	1/4	1.50	38	0.71	18		
34982-12-4	12	1/4	1.57	40	0.79	20		
34982-12-6	12	3/8	1.73	44	0.79	20		
34982-14-4	14	1/4	1.65	42	0.87	22		
34982-14-6	14	3/8	1.85	47	0.91	23		
34982-16-6	16	3/8	1.93	49	0.98	25		
34982-18-8	18	1/2	2.17	55	1.06	27		

### AM Banjo Bolt with DIN Metric Thread

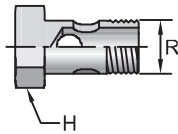

# Part Number	R Thread mm	H mm	Copper Washer (2)
AM-03	8 M8x1	12	853009-8
AM-04	10 M10x1	14	853009-10
AM-06	12 M12x1.5	17	853009-12
AM-08	14 M14x1.5	19	853009-14
AM-10	16 M16x1.5	22	853009-16
AM-13	18 M18x1.5	24	853009-18
AM-16	22 M22x1.5	27	853009-22
AM-20	26 M26x1.5	32	853009-26
AM-30	30 M30x1.5	36	853009-30

Two (2) copper washers per bolt must be ordered separately.

### 3CA82

Female Metric L - Swivel - (24° Cone with O-Ring)  
ISO 12151-2 - SWS

# Part Number	Thread		Hose I.D. inch	A		W mm	B	
	inch	M		inch	mm		inch	mm
3CA82-8-4	8	M14x1,5	1/4	1.42	36	17	0.67	17
3CA82-10-6	10	M16x1,5	3/8	1.57	40	19	0.67	17
3A82-10-6B	10	M16x1,5	3/8	1.57	40	19	0.67	17
3A82-12-6	12	M18x1,5	3/8	1.57	40	22	0.67	17
3A82-15-8	15	M22x1,5	1/2	1.73	44	27	0.71	18
3A82-22-12	22	M30x2	3/4	2.28	58	36	0.83	21

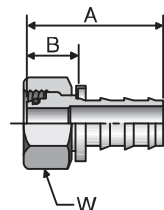

### 3CF82

Female Metric L - Swivel - 90° Elbow - (24° Cone with O-Ring)  
ISO 12151-2 - SWE

# Part Number	Thread		Hose I.D. inch	A		E		W mm	B	
	inch	M		inch	mm	inch	mm		inch	mm
3CF82-8-4	8	M14x1,5	1/4	1.65	42	1.26	32	17	0.91	23
3CF82-10-6	10	M16x1,5	3/8	1.93	49	1.38	35	19	1.06	27
3CF82-10-6B	10	M16x1,5	3/8	1.93	49	1.38	35	19	1.06	27
3CF82-12-6	12	M18x1,5	3/8	1.93	49	1.42	36	22	1.06	27
3CF82-15-8	15	M22x1,5	1/2	2.28	58	1.61	41	27	1.26	32
3CF82-22-12	22	M30x2	3/4	3.46	88	2.17	55	36	2.01	51

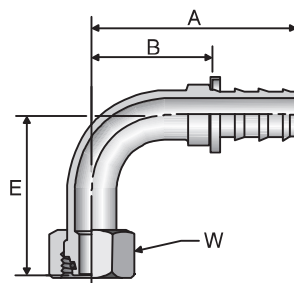

### 3C482

Female Metric L - Swivel - 45° Elbow - (Ball Nose)  
ISO 8434-1

# Part Number	Thread		Hose I.D. inch	A		E		W mm	B	
	inch	M		inch	mm	inch	mm		inch	mm
3C482-8-4B	8	M14x1,5	1/4	2.01	51	0.63	16	17	1.26	32
3C482-10-6B	10	M16x1,5	3/8	2.28	58	0.71	18	19	1.38	35
3C482-15-8B	15	M22x1,5	1/2	2.68	68	0.75	19	27	1.61	41
3C482-22-12	22	M30x2	3/4	3.46	88	0.91	23	36	2.05	52

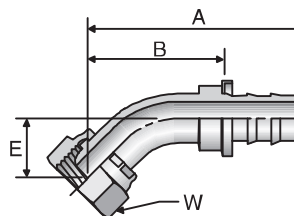

Hose  
A

Fittings 82 Series  
B

Equipment  
C

Accessories  
D

Technical  
E

Hose  
A

Fittings 82 Series  
B

Equipment  
C

Accessories  
D

Technical  
E

### 3C582

#### Female Metric L - Swivel - 90° Elbow - (Ball Nose)

ISO 8434-1

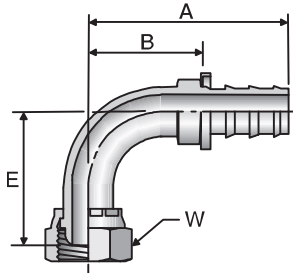

# Part Number	Thread inch	Hose I.D. inch	A		E		W mm	B	
			inch	mm	inch	mm		inch	mm
3C582-8-4B	8 M14x1,5	1/4	1.65	42	1.14	29	17	0.91	23
3C582-10-6B	10 M16x1,5	3/8	1.93	49	1.30	33	19	1.06	27
3C582-15-8B	15 M22x1,5	1/2	2.36	60	1.54	39	27	1.34	34
3C582-22-12B	22 M30x2	3/4	3.46	88	1.97	50	36	2.01	51

### 3C382

#### Female Metric L - Swivel - (Ball Nose)

ISO 8434-1

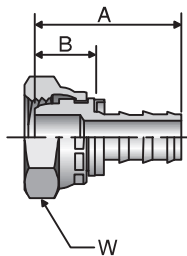

# Part Number	Thread inch	Hose I.D. inch	A		W mm	B	
			inch	mm		inch	mm
3C382-8-4B	8 M14x1,5	1/4	1.42	36	19	0.63	16
3C382-10-6B	10 M16x1,5	3/8	1.50	38	19	0.59	15
3C382-15-8B	15 M22x1,5	1/2	1.65	42	27	0.59	15
3C382-22-12B	22 M30x2	3/4	2.09	53	36	0.67	17