

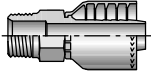









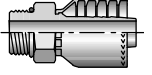

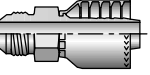
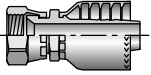
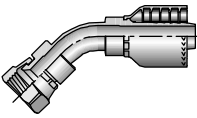
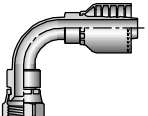
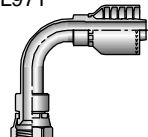
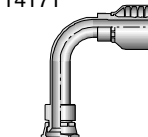

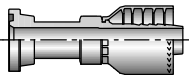
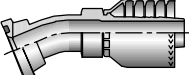
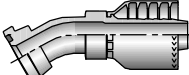
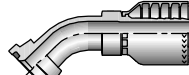
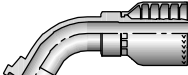
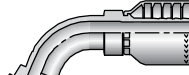
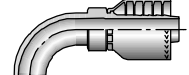
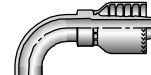
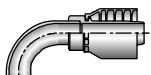
 NPTF Pipe	10171 B-72  <i>Male - Rigid</i>	 SAE	10571 B-72  <i>Male - Rigid</i>	 JIC	10371 B-72  <i>Male - Rigid</i>
10671 B-73  <i>Female - Swivel</i>	13771 B-73  <i>Female - Swivel 45° Elbow - Short</i>	13971 B-74  <i>Female - Swivel 90° Elbow - Short</i>	1L971 B-74  <i>Female - Swivel 90° Elbow - Medium</i>	14171 B-74  <i>Female - Swivel 90° Elbow - Long</i>	 Code 61 Flange
11571 B-75  <i>Flange</i>	11671 B-75  <i>22-1/2° Elbow</i>	12671 B-76  <i>30° Elbow</i>	11771 B-76  <i>45° Elbow</i>	12771 B-76  <i>60° Elbow</i>	11871 B-77  <i>67-1/2° Elbow</i>
11971 B-77  <i>90° Elbow</i>	18971 B-78  <i>90° Elbow-Long</i>	12U71 B-78  <i>110° Elbow</i>	 Code 62 Flange	16A71 B-78  <i>Flange</i>	16F71 B-78  <i>45° Elbow</i>
16N71 B-79  <i>90° Elbow</i>	 Seal-Lok® (O-Ring Face Seal)	1J071 B-79  <i>Male - Rigid</i>	1JC71 B-79  <i>Female - Swivel Short</i>	1JS71 B-80  <i>Female - Swivel Long</i>	1J771 B-80  <i>Female - Swivel 45° Elbow</i>
1J971 B-81  <i>Female - Swivel 90° Elbow - Short</i>	1J571 B-81  <i>Female - Swivel 90° Elbow - Medium</i>	1J171 B-81  <i>Female - Swivel 90° Elbow - Long</i>	 Metric "S"	1D271 B-82  <i>Male - Rigid</i>	1C971 B-82  <i>Female - Swivel</i>
 BSP	1UT71 B-82  <i>Male - Rigid</i>	1GU71 B-82  <i>Female - Swivel</i>	1FU71 B-83  <i>Female - Swivel</i>	 Metric	1MU71 B-83  <i>Female - Swivel</i>
1XU71 B-83  <i>Female - Swivel</i>					

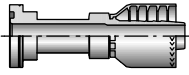
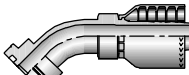
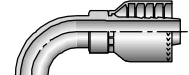
A

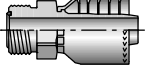
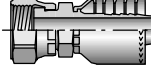
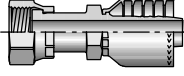
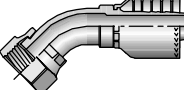
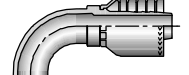
B

C

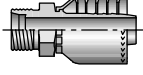
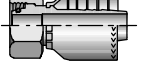
D

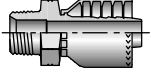
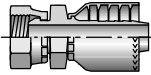
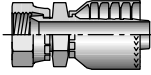
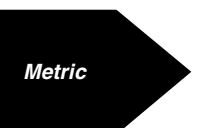
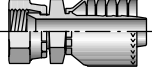
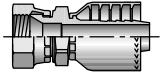
E

10171 Male NPTF Pipe - Rigid

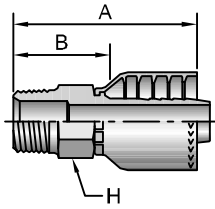

# Part Number	Thread		Hose I.D. inch	A		H inch	B	
	inch	inch		inch	mm		inch	mm
10171-6-6	3/8x18		3/8	2.36	60	3/4	1.47	37
10171-8-8	1/2x14		1/2	2.82	72	7/8	1.63	41
10171-12-8	3/4x14		1/2	2.67	68	1-1/16	1.47	37
10171-12-12	3/4x14		3/4	3.08	78	1-1/16	1.71	43
10171-16-12	1x11-1/2		3/4	3.08	78	1-3/8	1.72	44
10171-16-16	1x11-1/2		1	3.63	92	1-3/8	2.04	52
10171-20-16	1-1/4x11-1/2		1	3.49	89	1-11/16	1.90	48
10171-20-20	1-1/4x11-1/2		1-1/4	4.06	103	1-3/4	2.39	61
10171-24-20	1-1/2x11-1/2		1-1/4	3.77	96	2	2.10	53
10171-24-24	1-1/2x11-1/2		1-1/2	4.32	110	2	2.19	56
10171-32-32	2x11-1/2		2	4.72	118	2-1/2	2.52	64

10571 Male SAE Straight Thread with O-Ring - Rigid

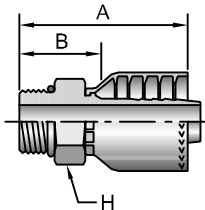

# Part Number	Thread		Hose I.D. inch	A		H inch	B	
	inch	inch		inch	mm		inch	mm
10571-8-8	1/2	3/4x16	1/2	2.44	62	7/8	1.25	32
10571-12-12	3/4	1-1/16x12	3/4	2.79	71	1-1/4	1.43	36
10571-16-16	1	1-5/16x12	1	3.42	87	1-1/2	1.77	45
10571-20-20	1-1/4	1-5/8x12	1-1/4	3.67	93	1-7/8	2.00	51

10371 Male JIC 37° - Rigid

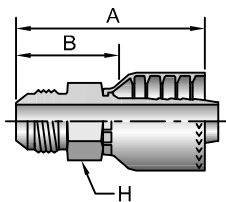

# Part Number	Thread		Hose I.D. inch	A		H inch	B	
	inch	inch		inch	mm		inch	mm
10371-6-6	3/8	9/16x18	3/8	2.44	62	3/4	1.55	39
10371-8-6	1/2	3/4x16	3/8	2.29	58	7/8	1.40	36
10371-8-8	1/2	3/4x16	1/2	2.66	68	7/8	1.41	36
10371-10-8	5/8	7/8x14	1/2	2.60	66	15/16	1.41	36
10371-10-10	5/8	7/8x14	5/8	2.93	74	15/16	1.69	43
10371-12-12	3/4	1-1/16x12	3/4	3.17	80	1-1/8	1.81	46
10371-14-12	7/8	1-3/16x12	3/4	3.09	78	1-1/4	1.73	44
10371-16-12	1	1-5/16x12	3/4	3.02	77	1-3/8	1.66	42
10371-16-16	1	1-5/16x12	1	3.68	93	1-3/8	2.03	52
10371-20-16	1-1/4	1-5/8x12	1	3.43	87	1-7/8	1.84	47
10371-20-20	1-1/4	1-5/8x12	1-1/4	3.94	100	1-7/8	2.27	58

10671

Female JIC 37° - Swivel

# Part Number	Thread		Hose I.D. inch	A		H inch	W inch	B		Additional Material Stainless Steel (C)
	inch	9/16x18		inch	mm			inch	mm	
10671-6-6	3/8	9/16x18	3/8	2.28	58	11/16	11/16	1.39	35	
10671-8-6	1/2	3/4x16	3/8	2.47	63	11/16	7/8	1.58	40	
10671-8-8	1/2	3/4x16	1/2	2.61	66	13/16	7/8	1.41	36	•
10671-10-8	5/8	7/8x14	1/2	2.84	72	7/8	1	1.64	42	
10671-10-10	5/8	7/8x14	5/8	2.83	72	15/16	1	1.58	40	
10671-10-12	5/8	7/8x14	3/4	2.92	74	1-1/16	1	1.54	39	
10671-12-8	3/4	1-1/16x12	1/2	2.75	70	1-1/16	1-1/4	1.58	40	
10671-12-10	3/4	1-1/16x12	5/8	3.00	76	1-1/16	1-1/4	1.75	44	
10671-12-12	3/4	1-1/16x12	3/4	2.96	75	1-1/16	1-1/4	1.60	41	•
10671-12-16	3/4	1-1/16x12	1	3.37	86	1-3/8	1-1/4	1.67	42	
10671-14-12	7/8	1-3/16x12	3/4	3.01	76	1-1/4	1-3/8	1.61	41	
10671-16-12	1	1-5/16x12	3/4	3.28	83	1-1/4	1-1/2	1.92	49	
10671-16-16	1	1-5/16x12	1	3.60	91	1-3/8	1-1/2	2.01	51	•
10671-20-16	1-1/4	1-5/8x12	1	3.80	97	1-5/8	2	2.21	56	
10671-20-20	1-1/4	1-5/8x12	1-1/4	3.92	100	1-7/8	2	2.25	57	•
10671-24-20	1-1/2	1-7/8x12	1-1/4	4.10	104	2-1/8	2-1/4	2.43	62	
10671-24-24	1-1/2	1-7/8x12	1-1/2	4.69	119	2-1/8	2-1/4	2.50	64	•
10671-32-32	2	2-1/2x12	2	5.39	137	2-1/2	2-7/8	3.19	81	

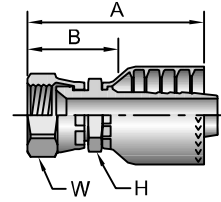

A

B

C

13771

Female JIC 37° - Swivel - 45° Elbow - Short Drop

# Part Number	Thread		Hose I.D. inch	A		E		W inch	B	
	inch	9/16x18		inch	mm	inch	mm		inch	mm
13771-6-6	3/8	9/16x18	3/8	2.34	59	0.43	11	11/16	1.44	37
13771-8-8	1/2	3/4x16	1/2	2.83	72	0.59	15	7/8	1.62	41
13771-10-8	5/8	7/8x14	1/2	2.93	74	0.63	16	1	1.72	44
13771-10-10	5/8	7/8x14	5/8	3.08	78	0.63	16	1	1.83	46
13771-12-12	3/4	1-1/16x12	3/4	3.64	92	0.83	21	1-1/4	2.26	57
13771-16-16	1	1-5/16x12	1	4.20	107	0.90	23	1-1/2	2.61	66
13771-20-20	1-1/4	1-5/8x12	1-1/4	5.22	133	1.69	43	2	3.53	90

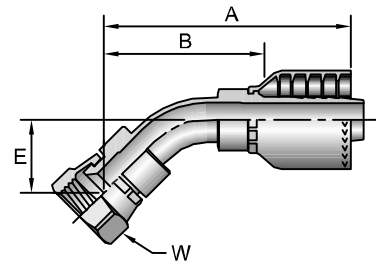

D

E

Stainless steel fittings must be assembled with Karrykrimp 2, PHastkrimp, Superkrimp or Parkrimp 2. See CrimpSource for more information.

13971

Female JIC 37° - Swivel - 90° Elbow - Short Drop

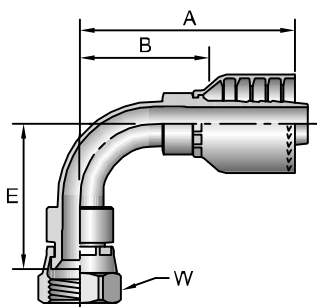

# Part Number	Thread		Hose I.D. inch	A		E		W inch	B	
	inch	9/16x18		inch	mm	inch	mm		inch	mm
13971-6-6	3/8	9/16x18	3/8	2.21	56	0.91	23	11/16	1.31	33
13971-8-8	1/2	3/4x16	1/2	2.62	67	1.14	29	7/8	1.41	36
13971-10-8	5/8	7/8x14	1/2	2.74	70	1.26	32	1	1.53	39
13971-10-10	5/8	7/8x14	5/8	2.88	73	1.26	32	1	1.63	41
13971-12-10	3/4	1-1/16x12	5/8	2.98	76	1.89	48	1-1/4	1.73	44
13971-12-12	3/4	1-1/16x12	3/4	3.50	89	1.89	48	1-1/4	2.11	54
13971-16-16	1	1-5/16x12	1	4.36	111	2.20	56	1-1/2	2.58	66
13971-20-20	1-1/4	1-5/8x12	1-1/4	4.78	121	3.33	85	2	3.11	79
13971-24-24	1-1/2	1-7/8x12	1-1/2	6.33	161	3.98	101	2-1/4	4.14	105

1L971

Female JIC 37° - Swivel - 90° Elbow - Medium Drop

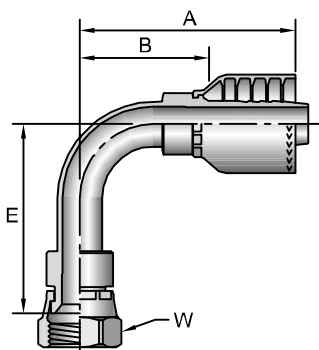

# Part Number	Thread		Hose I.D. inch	A		E		W inch	B	
	inch	7/8x14		inch	mm	inch	mm		inch	mm
1L971-10-8	5/8	7/8x14	1/2	3.24	82	1.75	44	1	2.04	52

14171

Female JIC 37° - Swivel - 90° Elbow - Long Drop

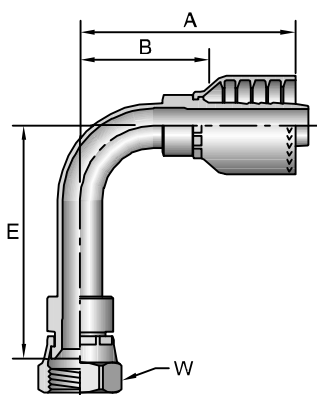

# Part Number	Thread		Hose I.D. inch	A		E		W inch	B	
	inch	1-5/16x12		inch	mm	inch	mm		inch	mm
14171-6-6	3/8	9/16x18	3/8	2.34	59	2.13	54	11/16	1.44	37
14171-8-8	1/2	3/4x16	1/2	2.58	66	2.52	64	7/8	1.37	35
14171-12-12	3/4	1-1/16x14	3/4	3.49	89	3.78	96	1-1/4	2.11	54
14171-16-16	1	1-5/16x12	1	4.36	111	4.32	110	1-1/2	2.58	66

11571

SAE Code 61 Flange Head

ISO 12151-3 - S - L

# Part Number	Flange inch	Hose I.D. inch	A		F inch	B	
			inch	mm		inch	mm
11571-8-8	1/2	1/2	3.48	88	1-3/16	2.27	58
11571-10-10	5/8	5/8	3.69	93,7	1-11/32	2.44	62,0
11571-12-8	3/4	1/2	2.46	62,5	1-1/2	1.26	32,0
11571-12-12	3/4	3/4	3.86	98	1-1/2	2.48	63
11571-16-12	1	3/4	2.74	70	1-3/4	1.36	35
11571-16-16	1	1	4.32	110	1-3/4	2.55	65
11571-20-12	1-1/4	3/4	3.90	99	2	2.54	65
11571-20-16	1-1/4	1	3.27	83	2	1.58	40
11571-20-20	1-1/4	1-1/4	4.70	119	2	3.01	76
11571-20-24	1-1/4	1-1/2	5.41	137	2	3.22	82
11571-24-16	1-1/2	1	3.41	86,6	2-3/8	1.63	41,4
11571-24-20	1-1/2	1-1/4	3.48	104	2-3/8	1.36	61
11571-24-24	1-1/2	1-1/2	5.46	139	2-3/8	3.27	83
11571-24-32	1-1/2	2	5.65	144	2-3/8	3.45	88
11571-32-20	2	1-1/4	4.29	109,0	2-13/16	2.60	66,0
11571-32-24	2	1-1/2	4.01	102	2-13/16	1.82	46
11571-32-32	2	2	5.65	144	2-13/16	3.45	88
11571-40-32	2-1/2	2	4.51	115	3-5/16	2.31	59

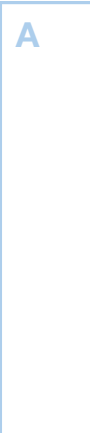
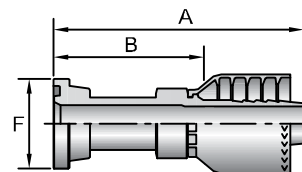

11671

SAE Code 61 Flange Head - 22-1/2° Elbow

ISO 12151-3 - E22M - L

# Part Number	Flange inch	Hose I.D. inch	A		E		F inch	B	
			inch	mm	inch	mm		inch	mm
11671-12-12	3/4	3/4	3.90	99	0.44	11	1-1/2	2.54	65
11671-16-12	1	3/4	3.89	99	0.44	11	1-3/4	2.53	64
11671-16-16	1	1	4.26	108	0.44	11	1-3/4	2.67	68
11671-20-16	1-1/4	1	4.36	111	0.47	12	2	2.77	70
11671-20-20	1-1/4	1-1/4	4.67	119	0.50	13	2	3.00	76
11671-24-20	1-1/2	1-1/4	4.68	119	0.53	13	2-3/8	3.01	76
11671-24-24	1-1/2	1-1/2	5.88	149	0.63	16	2-3/8	3.69	94
11671-32-32	2	2	7.37	187	0.88	22	2-13/16	5.22	133

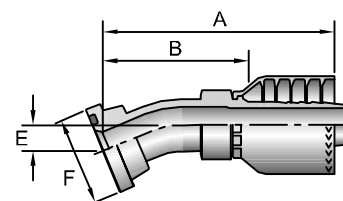

See Accessories Section for O-Rings and Flange Kits.

12671

SAE Code 61 Flange Head - 30° Elbow

ISO 12151-3 - E30S - L (1 Piece: ISO 12151-3 - E30M - L)

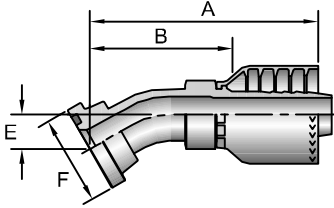

# Part Number	Flange inch	Hose I.D. inch	A		E		F inch	B	
			inch	mm	inch	mm		inch	mm
12671-12-12	3/4	3/4	3.90	99	0.59	15	1-1/2	2.52	64
12671-16-16	1	1	4.46	113	0.62	16	1-3/4	2.68	68
12671-20-16	1-1/4	1	4.46	113	0.62	16	2	2.68	68
12671-20-20	1-1/4	1-1/4	4.87	124	0.72	18	2	3.18	81
12671-24-24	1-1/2	1-1/2	6.01	153	0.88	22	2-3/8	3.82	97
12671-32-24	2	1-1/2	6.01	153	0.88	22	2-13/16	3.82	97
12671-32-32	2	2	7.60	193	1.25	32	2-13/16	5.40	137

11771

SAE Code 61 Flange Head - 45° Elbow

ISO 12151-3 - E45S - L (1 Piece: ISO 12151-3 - E45M - L)

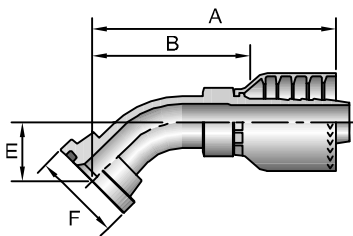

# Part Number	Flange inch	Hose I.D. inch	A		E		F inch	B	
			inch	mm	inch	mm		inch	mm
11771-10-10	5/8	5/8	4.54	115	0.94	24	1-11/32	3.29	84
11771-12-8	3/4	1/2	3.27	83	0.84	21	1-1/2	2.07	53
11771-12-10	3/4	5/8	3.94	100	0.76	19	1-1/2	2.70	69
11771-12-12	3/4	3/4	3.85	98	1.02	26	1-1/2	2.47	63
11771-16-12	1	3/4	3.85	98	1.02	26	1-3/4	2.47	63
11771-16-16	1	1	4.84	123	1.26	32	1-3/4	3.06	78
11771-20-16	1-1/4	1	4.84	123	1.02	26	2	3.06	78
11771-20-20	1-1/4	1-1/4	5.61	142	1.50	38	2	3.92	100
11771-20-24	1-1/4	1-1/2	6.22	158	1.12	28	2	4.03	102
11771-24-20	1-1/2	1-1/4	5.55	141	1.50	38	2-3/8	3.86	98
11771-24-24	1-1/2	1-1/2	6.22	158	1.41	36	2-3/8	4.03	102
11771-32-24	2	1-1/2	6.19	157	1.41	36	2-13/16	4.00	102
11771-32-32	2	2	7.94	202	2.03	52	2-13/16	5.74	146
11771-40-32	2-1/2	2	7.83	199	2.03	52	3-5/16	5.62	143

12771

SAE Code 61 Flange Head - 60° Elbow

ISO 12151-3 - E60S - L (1 Piece: ISO 12151-3 - E60M - L)

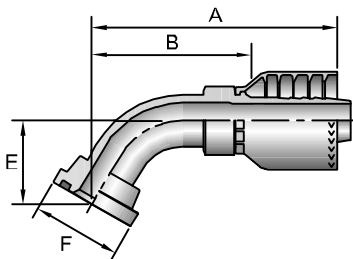

# Part Number	Flange inch	Hose I.D. inch	A		E		F inch	B	
			inch	mm	inch	mm		inch	mm
12771-12-12	3/4	3/4	4.16	106	1.43	36	1-1/2	2.78	71
12771-16-12	1	3/4	4.15	105	1.39	35	1-3/4	2.77	70
12771-16-16	1	1	4.74	120	1.49	38	1-3/4	3.36	85
12771-20-20	1-1/4	1-1/4	5.10	130	1.69	43	2	3.41	87
12771-24-20	1-1/2	1-1/4	5.12	130	1.70	43	2-3/8	3.43	87
12771-24-24	1-1/2	1-1/2	6.25	159	2.03	52	2-3/8	4.06	103
12771-32-32	2	2	7.93	201	2.88	73	2-13/16	5.73	146

See Accessories Section for O-Rings and Flange Kits.

11871

SAE Code 61 Flange Head - 67-1/2° Elbow

ISO 12151-3 - E67S - L (1 Piece: ISO 12151-3 - E67M - L)

# Part Number	Flange inch	Hose I.D. inch	A		E		F inch	B	
			inch	mm	inch	mm		inch	mm
11871-12-12	3/4	3/4	4.12	105	1.62	41	1-1/2	2.74	70
11871-16-12	1	3/4	4.11	104	1.59	40	1-3/4	2.73	69
11871-16-16	1	1	4.76	121	1.75	44	1-3/4	2.98	76
11871-20-20	1-1/4	1-1/4	5.08	129	1.94	49	2	3.39	86
11871-24-20	1-1/2	1-1/4	5.07	129	1.95	50	2-3/8	3.38	86
11871-24-24	1-1/2	1-1/2	6.20	157	2.31	59	2-3/8	4.01	102
11871-32-24	2	1-1/2	6.20	157	2.31	59	2-13/16	4.01	102
11871-32-32	2	2	7.89	200	3.31	84	2-13/16	5.69	145

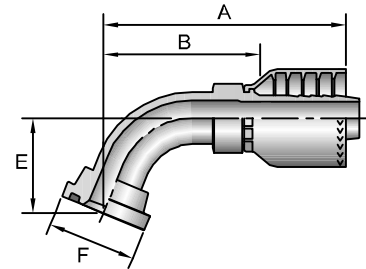

11971

SAE Code 61 Flange Head - 90° Elbow

ISO 12151-3 - E90S - L (1 Piece: ISO 12151-3 - E90M - L)

# Part Number	Flange inch	Hose I.D. inch	A		E		F inch	B	
			inch	mm	inch	mm		inch	mm
11971-8-8	1/2	1/2	2.93	74	1.6	41	1-3/16	1.72	44
11971-10-10	5/8	5/8	3.62	92	2.10	53	1-11/32	2.37	60
11971-12-8	3/4	1/2	2.93	74	1.66	42	1-1/2	1.72	44
11971-12-10	3/4	5/8	3.62	92	2.10	53	1-1/2	2.37	60
11971-12-12	3/4	3/4	3.48	88	2.28	58	1-1/2	2.10	53
11971-16-12	1	3/4	3.52	89	2.28	58	1-3/4	2.14	54
11971-16-16	1	1	4.36	111	2.76	70	1-3/4	2.58	66
11971-16-20	1	1-1/4	4.53	115	2.39	61	1-3/4	2.75	70
11971-20-12	1-1/4	3/4	3.81	97	2.13	54	2	2.45	62
11971-20-16	1-1/4	1	4.33	110	2.76	70	2	2.55	65
11971-20-20	1-1/4	1-1/4	5.12	130	3.54	90	2	3.43	87
11971-20-24	1-1/4	1-1/2	6.33	161	3.00	76	2	4.14	105
11971-24-16	1-1/2	1	4.53	115	2.39	61	2-3/8	2.75	70
11971-24-20	1-1/2	1-1/4	5.09	129	3.54	90	2-3/8	3.40	86
11971-24-24	1-1/2	1-1/2	6.34	161	4.09	104	2-3/8	4.15	105
11971-32-24	2	1-1/2	6.98	148	4.09	79	2-13/16	4.36	93
11971-32-32	2	2	7.75	197	5.43	138	2-13/16	5.55	141
11971-40-32	2-1/2	2	7.43	189	4.5	114	3-5/16	5.23	133

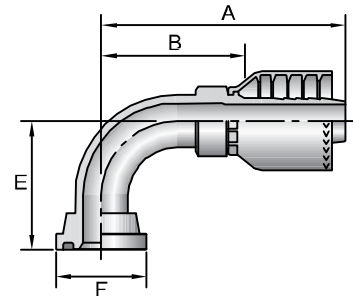

See Accessories Section for O-Rings and Flange Kits.

A

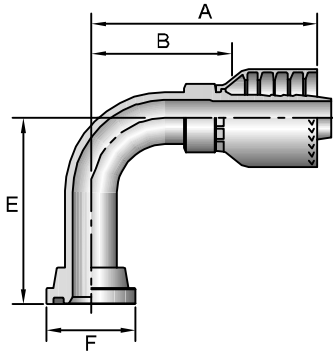

B

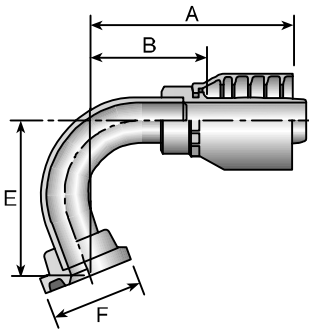

C

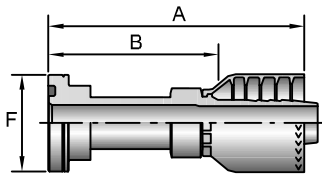

D

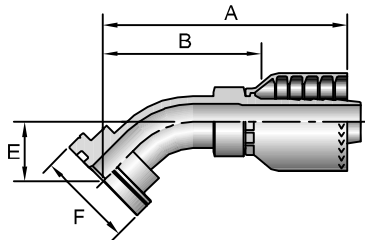

E

18971

SAE Code 61 Flange Head - 90° Elbow - Long Drop

# Part Number	Flange inch	Hose I.D. inch	A		E		F inch	B	
			inch	mm	inch	mm		inch	mm
18971-12-12	3/4	3/4	3.49	89	3.03	77	1-1/2	2.11	54
18971-16-16	1	1	4.52	115	4.60	117	1-3/4	2.74	70
18971-20-16	1-1/4	1	4.53	115	4.60	117	2	2.75	70

12U71

SAE Code 61 Flange Head - 110° Elbow

# Part Number	Flange inch	Hose I.D. inch	A		E		F inch	B	
			inch	mm	inch	mm		inch	mm
12U71-16-16	1	1	4.49	114	3.69	94	1-3/4	2.71	69

16A71

SAE Code 62 Flange Head
ISO 12151-3 - S - S

# Part Number	Flange inch	Hose I.D. inch	A		F inch	B	
			inch	mm		inch	mm
16A71-12-12	3/4	3/4	4.31	109	1-5/8	2.93	74
16A71-16-12	1	3/4	3.10	78,7	1-7/8	1.72	43,7
16A71-16-16	1	1	4.89	124	1-7/8	3.11	79
16A71-20-16	1-1/4	1	3.69	93,7	2-1/8	1.91	48,5
16A71-20-20	1-1/4	1-1/4	5.01	127,3	2-1/8	3.32	84,3
16A71-24-24	1-1/2	1-1/2	6.34	161,0	2-1/2	4.15	105,4
16A71-32-32	2	2	7.16	182	3-1/8	4.96	126

16F71

SAE Code 62 Flange Head - 45° Elbow
ISO 12151-3 - E45S - L (1 Piece: ISO 12151-3 - E45M - S)

# Part Number	Flange inch	Hose I.D. inch	A		E		F inch	B	
			inch	mm	inch	mm		inch	mm
16F71-12-12	3/4	3/4	3.82	97	1.03	26	1-5/8	2.44	62
16F71-16-16	1	1	4.74	120,3	1.26	32	1-7/8	2.96	75,2
16F71-20-16	1-1/4	1	4.61	117	1.06	27	2-1/8	3.02	77
16F71-20-20	1-1/4	1-1/4	5.07	129	1.19	30	2-1/8	3.38	86
16F71-24-24	1-1/2	1-1/2	6.21	158	1.44	37	2-1/2	4.02	102
16F71-32-32	2	2	7.87	200	2.05	52	3-1/8	5.67	144

See Accessories Section for O-Rings and Flange Kits.

16N71

SAE Code 62 Flange Head - 90° Elbow

ISO 12151-3 - E90S - L (1 Piece: ISO 12151-3 - E90M - S)

# Part Number	Flange inch	Hose I.D. inch	A		E		F		B	
			inch	mm	inch	mm	inch	inch	mm	
16N71-12-12	3/4	3/4	3.51	89	2.28	58	1-5/8	2.13	54	
16N71-16-12	1	3/4	3.49	89	2.29	58	1-7/8	2.11	54	
16N71-16-16	1	1	4.36	111	2.76	70	1-7/8	2.58	66	
16N71-20-16	1-1/4	1	4.36	111	2.76	70	2-1/8	2.58	66	
16N71-20-20	1-1/4	1-1/4	5.09	129	3.54	90	2-1/8	3.40	86	
16N71-24-24	1-1/2	1-1/2	5.85	149	3.12	79	2-1/2	3.66	93	
16N71-32-32	2	2	7.73	196	4.50	114	3-1/8	5.53	140	

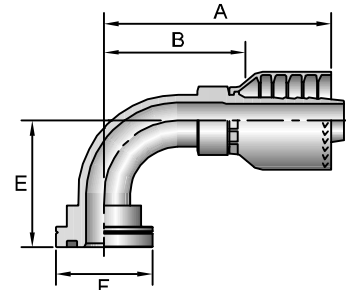

⚠ Refer to Pressure Rating of Hose End Connections chart on page E-45.

1J071

Male Seal-Lok® - Rigid - (with O-Ring)

ISO 12151-1 - S

# Part Number	Thread inch		Hose I.D. inch	A		H inch	B	
	inch	mm		inch	mm		inch	mm
1J071-8-8	1/2	13/16x16	1/2	2.40	61	7/8	1.20	30
1J071-10-8	5/8	1x14	1/2	2.61	66	1-1/16	1.41	36
1J071-10-10	5/8	1x14	5/8	2.69	68	1-1/16	1.44	37
1J071-12-10	3/4	1-3/16x12	5/8	2.79	71	1-1/4	1.55	39
1J071-12-12	3/4	1-3/16x12	3/4	2.87	73	1-1/4	1.51	38
1J071-16-12	1	1-7/16x12	3/4	2.91	74	1-1/2	1.53	39
1J071-16-16	1	1-7/16x12	1	3.27	83	1-1/2	1.68	43
1J071-20-20	1-1/4	1-11/16x12	1-1/4	3.31	84	1-3/4	1.64	42
1J071-24-24	1-1/2	2x12	1-1/2	4.02	102	2-1/8	1.83	46

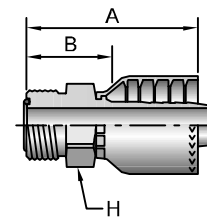

1JC71

Female Seal-Lok® - Swivel - Short

ISO 12151-1 - SWSA

# Part Number	Thread inch		Hose I.D. inch	A		C inch	H		W		B	
	inch	mm		inch	mm		inch	inch	inch	mm		
1JC71-8-8	1/2	13/16x16	1/2	2.22	56	0.43	11	13/16	15/16	1.01	26	
1JC71-10-10	5/8	1x14	5/8	2.40	61	0.48	12	15/16	1-1/8	1.15	29	
1JC71-12-12	3/4	1-3/16x12	3/4	2.68	68	0.55	14	1-1/8	1-3/8	1.30	33	
1JC71-16-16	1	1-7/16x12	1	3.22	82	0.56	14	1-3/8	1-5/8	1.44	37	
1JC71-20-16	1-1/4	1-11/16x12	1	3.16	80	0.59	15	1-5/8	1-7/8	1.38	35	

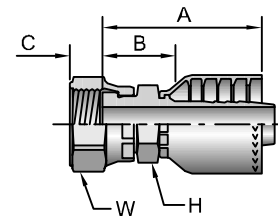

When measuring overall length to end of nut, B+C dimensions must be used to calculate cut-off allowance.

See Accessories Section for O-Rings and Flange Kits.

1JS71

Female Seal-Lok® - Swivel - Long

ISO 12151-1 - SWSB

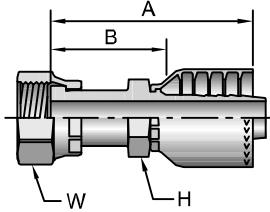

# Part Number	Thread		Hose I.D. inch	A		H inch	W inch	B	
	inch	inch		inch	mm			inch	mm
1JS71-6-6	3/8	11/16x16	3/8	2.80	58	11/16	13/16	1.38	35
1JS71-6-8	3/8	11/16x16	1/2	2.50	64	13/16	13/16	1.29	33
1JS71-8-8	1/2	13/16x16	1/2	2.64	67	13/16	15/16	1.44	37
1JS71-10-8	5/8	1x14	1/2	2.89	23	13/16	1-1/8	1.69	43
1JS71-10-10	5/8	1x14	5/8	3.00	76	15/16	1-1/8	1.75	44
1JS71-10-12	5/8	1x14	3/4	3.08	78	1-1/16	1-1/8	1.70	43
1JS71-12-10	3/4	1-3/16x12	5/8	3.10	79	1-1/8	1-3/8	1.85	47
1JS71-12-12	3/4	1-3/16x12	3/4	3.31	84	1-1/16	1-3/8	1.93	49
1JS71-16-12	1	1-7/16x12	3/4	3.37	86	1-5/16	1-5/8	1.99	51
1JS71-16-16	1	1-7/16x12	1	3.70	94	1-5/16	1-5/8	1.92	49
1JS71-20-16	1-1/4	1-11/16x12	1	3.64	92	1-3/4	1-7/8	1.94	49
1JS71-20-20	1-1/4	1-11/16x12	1-1/4	3.77	96	1-3/4	1-7/8	2.08	53
1JS71-24-24	1-1/2	2x12	1-1/2	4.51	114,6	2	2-1/4	2.32	58,9

1J771

Female Seal-Lok® - Swivel - 45° Elbow

ISO 12151-1 - SWE45

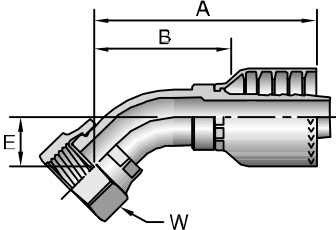

# Part Number	Thread		Hose I.D. inch	A		E		W inch	B	
	inch	inch		inch	mm	inch	mm		inch	mm
1J771-6-6	3/8	11/16x16	3/8	2.34	59	0.43	11	13/16	1.44	37
1J771-8-8	1/2	13/16x16	1/2	2.83	72	0.59	15	15/16	1.62	41
1J771-10-8	5/8	1x14	1/2	2.93	74	0.63	16	1-1/8	1.72	44
1J771-10-10	5/8	1x14	5/8	3.08	78	0.63	16	1-1/8	1.83	46
1J771-12-12	3/4	1-3/16x12	3/4	3.63	92	0.83	21	1-3/8	2.25	57
1J771-16-16	1	1-7/16x12	1	4.46	113	0.94	24	1-5/8	2.68	68
1J771-20-20	1-1/4	1-11/16x12	1-1/4	4.75	121	1.00	25	1-7/8	3.08	78
1J771-24-24	1-1/2	2x12	1-1/2	5.43	138	1.07	27	2-1/4	3.23	82

See Accessories Section for O-Rings.

1J971

Female Seal-Lok® - Swivel - 90° Elbow - Short Drop
ISO 12151-1 - SWES90

# Part Number	Thread		Hose I.D. inch	A		E		W inch	B	
	inch			inch	mm	inch	mm		inch	mm
1J971-6-6	3/8	11/16x16	3/8	2.21	56	0.91	23	13/16	1.31	33
1J971-8-8	1/2	13/16x16	1/2	2.59	66	1.14	29	15/16	1.38	35
1J971-10-8	5/8	1x14	1/2	2.74	70	1.26	32	1-1/8	1.53	39
1J971-10-10	5/8	1x14	5/8	2.88	73	1.26	32	1-1/8	1.63	41
1J971-10-12	5/8	1x14	3/4	3.07	78	1.27	32	1-1/8	1.70	43
1J971-12-10	3/4	1-3/16x12	5/8	3.40	86	1.89	48	1-3/8	2.15	55
1J971-12-12	3/4	1-3/16x12	3/4	3.49	89	1.89	48	1-3/8	2.11	54
1J971-16-16	1	1-7/16x12	1	4.36	111	2.20	56	1-5/8	2.58	66
1J971-20-20	1-1/4	1-11/16x12	1-1/4	4.86	123	2.51	64	1-7/8	3.19	81
1J971-24-24	1-1/2	2x12	1-1/2	6.22	158	2.68	68	2-1/4	4.03	102

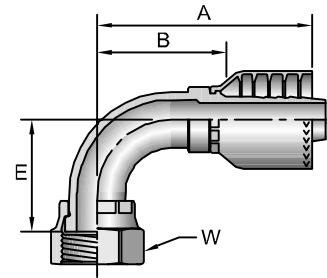

1J571

Female Seal-Lok® - Swivel - 90° Elbow - Medium Drop
ISO 12151-1 - SWEM90

# Part Number	Thread		Hose I.D. inch	A		E		W inch	B	
	inch			inch	mm	inch	mm		inch	mm
1J571-8-8	1/2	13/16x16	1/2	2.59	66	1.61	41	15/16	1.38	35
1J571-10-10	5/8	1x14	5/8	2.88	73	1.85	47	1-1/8	1.63	41
1J571-12-12	3/4	1-3/16x12	3/4	3.49	89	2.28	58	1-3/8	2.11	54

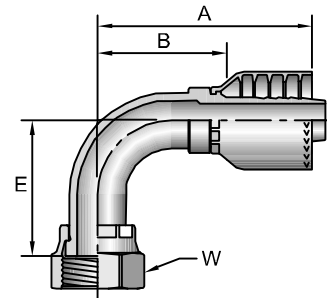

1J171

Female Seal-Lok® - Swivel - 90° Elbow - Long Drop
ISO 12151-1 - SWEL90

# Part Number	Thread		Hose I.D. inch	A		E		W inch	B	
	inch			inch	mm	inch	mm		inch	mm
1J171-6-6	3/8	11/16x16	3/8	2.39	61	2.13	54	13/16	1.49	38
1J171-8-8	1/2	13/16x16	1/2	2.59	66	2.52	64	15/16	1.38	35
1J171-10-10	5/8	1x14	5/8	2.88	73	2.76	70	1-1/8	1.63	41
1J171-12-12	3/4	1-3/16x12	3/4	3.49	89	3.78	96	1-3/8	2.11	54
1J171-16-12	1	1-7/16x12	3/4	4.07	103	4.50	114	1-5/8	2.69	68
1J171-16-16	1	1-7/16x12	1	4.36	111	4.49	114	1-5/8	2.58	66
1J171-20-20	1-1/4	1-11/16x12	1-1/4	4.88	124	5.09	129	1-7/8	3.19	81
1J171-24-24	1-1/2	2x12	1-1/2	5.83	148	5.54	141	2-1/4	3.64	92

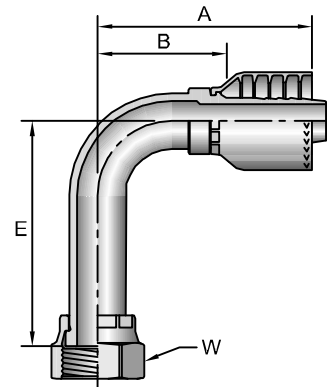

See Accessories Section for O-Rings.

1D271

Male Metric S - Rigid - (24° Cone)
ISO 12151-2

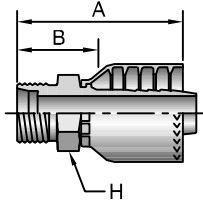

# Part Number	Thread mm	Hose I.D. inch	A		H mm	B	
			inch	mm		inch	mm
1D271-25-12	25 M36x2	3/4	2.90	74	36	1.52	39
1D271-30-16	30 M42x2	1	3.45	88	46	1.67	42

1C971

Female Metric S - Swivel - (24° Cone with O-Ring)
ISO 12151-2 - SWS - S

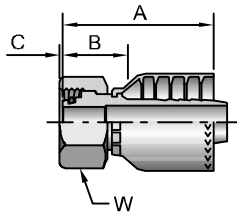

# Part Number	Thread mm	Hose I.D. inch	A		C		W mm	B	
			inch	mm	inch	mm		inch	mm
1C971-12-6	12 M20x1,5	3/8	2.05	52	0.03	1	24	0.87	22
1C971-16-8	16 M24x1,5	1/2	2.33	59	0.09	2	30	0.94	24
1C971-20-10	20 M30x2	5/8	2.60	66	0.05	1	36	1.06	27
1C971-25-12	25 M36x2	3/4	2.68	68	0.10	3	46	1.10	28
1C971-30-16	30 M42x2	1	3.07	78	0.19	5	50	1.30	33
1C971-38-20	38 M52x2	1-1/4	3.15	80	0.23	6	60	1.30	33

When measuring overall length to end of nut, B+C dimensions must be used to calculate cut-off allowance.

1UT71

Male BSP Taper Pipe - Rigid - (60° Cone)

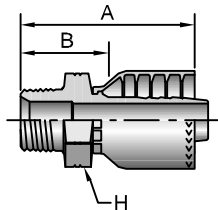

# Part Number	Hose I.D. inch	A		H mm	B	
		inch	mm		inch	mm
1UT71-8-8	1/2	2.66	68	27	1.46	37
1UT71-12-12	3/4	2.95	75	36	1.59	40

1GU71

Female BSP Parallel Pipe - Swivel - (60° Cone)

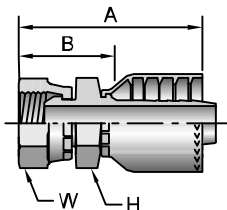

# Part Number	Thread inch		Hose I.D. inch	A		H mm	W mm	B	
	inch	mm		inch	mm			inch	mm
1GU71-6-6	3/8	3/8x19	3/8	2.45	62	22	22	1.55	39
1GU71-8-8	1/2	1/2x14	1/2	2.81	71	27	27	1.61	41
1GU71-12-12	3/4	3/4x14	3/4	3.24	82	36	36	1.86	47
1GU71-16-16	1	1x11	1	3.82	97	41	41	2.04	52
1GU71-20-20	1-1/4	1-1/4x11	1-1/4	4.07	103	50	50	2.38	60
1GU71-24-24	1-1/2	1-1/2x11	1-1/2	4.81	122	60	60	2.62	67
1GU71-32-32	2	2x11	2	5.17	131	70	70	2.97	75

Metric S: Mates with EO "S" Series Fittings.

^^ Must be assembled with Die Part No. 83C-D20H in a Superkrimp or Parkrimp 2.

See Accessories Section for O-Rings and Flange Kits.

1FU71

Female BSP Parallel Pipe - Swivel - (30° Flare)

# Part Number	Thread inch	Hose I.D. inch	A		H mm	W mm	B	
			inch	mm			inch	mm
1FU71-6-6	3/8x19	3/8	2.39	61	24	22	1.50	38
1FU71-8-8	1/2x14	1/2	2.71	69	27	27	1.51	38
1FU71-12-12	3/4x14	3/4	3.10	79	36	36	1.74	44
1FU71-16-16	1x11	1	3.52	89	41	41	1.93	49
1FU71-20-20	1-1/4x11	1-1/4	3.87	98	50	50	2.20	56
1FU71-24-24	1-1/2x11	1-1/2	4.66	118	60	60	2.53	64

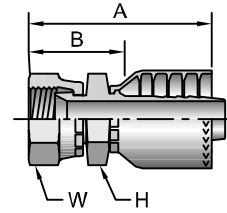

1MU71

Female Metric - Swivel - (30° Flare)

# Part Number	Thread inch	Hose I.D. inch	A		H mm	W mm	B	
			inch	mm			inch	mm
1MU71-6-6	M18x1,5	3/8	2.45	62	24	24	1.56	40
1MU71-8-8	M22x1,5	1/2	2.83	72	27	27	1.45	37

Japanese Fittings - Female Swivel 30° Flare with Metric Threads. All 30° flared fitting sizes are available by combining 1MU71 fittings in sizes up to 1/2 with 1XU71 fittings in sizes 5/8 inch and larger.

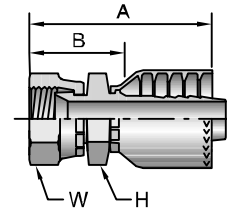

1XU71

Female Metric - Swivel - (30° Flare)

# Part Number	Thread inch	Hose I.D. inch	A		H mm	W mm	B	
			inch	mm			inch	mm
1XU71-10-10	M24x1,5	5/8	3.16	80	30	32	1.91	49
1XU71-12-12	M30x1,5	3/4	3.40	86	32	36	2.02	51
1XU71-16-16	M33x1,5	1	4.11	104	36	41	2.33	59
1XU71-20-20	M36x1,5	1-1/4	4.19	106	46	46	2.50	64
1XU71-24-24	M42x1,5	1-1/2	5.00	127	50	55	2.80	71

Japanese Fittings - Female Swivel 30° Flare with Metric Threads. All 30° flared fitting sizes are available by combining 1MU71 fittings in sizes up to 1/2 with 1XU71 fittings in sizes 5/8 inch and larger.

